

DF II Series
Digital Force Gauges
for DFS II, DFS II-R, DFS II-R-ND and DFE II Models

User Manual



WARRANTY

This instrument is warranted against defects in workmanship, material and design for one (1) year from date of delivery to the extent that AMETEK® will, at its sole option, repair or replace the instrument or any part thereof which is defective, provided, however, that this warranty shall not apply to instruments subjected to tampering or, abuse, or exposed to highly corrosive conditions.

THIS WARRANTY IS IN LIEU OF ALL OTHER WARRANTIES WHETHER EXPRESS OR IMPLIED AND AMETEK® HEREBY DISCLAIMS ALL OTHER WARRANTIES, INCLUDING, WITHOUT LIMITATION, ANY WARRANTY OF FITNESS FOR A PARTICULAR PURPOSE OR MERCHANTABILITY. AMETEK® SHALL NOT BE LIABLE FOR ANY INCIDENTAL OR CONSEQUENTIAL DAMAGES, INCLUDING, BUT NOT LIMITED TO, ANY ANTICIPATED OR LOST PROFITS.

This warranty is voidable if the purchaser fails to follow any and all instructions, warnings or cautions in the instrument's Instruction Manual.

If a manufacturing defect is found, AMETEK® will replace or repair the instrument or replace any defective part thereof without charge; however, AMETEK®'s obligation hereunder does not include the cost of transportation, which must be borne by the customer. AMETEK® assumes no responsibility for damage in transit, and any claims for such damage should be presented to the carrier by the purchaser.

TRADEMARKS

AMETEK® is a registered trademarks of AMETEK®, Inc.
Chatillon® is a registered trademark of AMETEK®, Inc.
Other trademarks are the property of their respective owners.

SUPPORT

AMETEK® Measurement & Calibration Technologies
8600 Somerset Drive
Largo, FL 33773
United States of America

Tel: +1 800 527 9999 (toll free within continental U.S.A.)

Tel: +1 727 538 6000

Fax: +1 727 539 6882

Email: chatillon.fl-lar@ametek.com

Internet: www.ametektest.com

ICONS



WARNING

The raised hand icon warns of a situation or condition that may lead to personal injury or death. Do not proceed until the warning is read and thoroughly understood. Warning messages are shown in bold type.



DANGEROUS VOLTAGE

The lightning icon warns of the presence of an uninsulated dangerous voltage within the product enclosure that might be of sufficient magnitude to cause serious shocks or death. Never open the enclosures unless you are an authorized and qualified Chatillon® service personnel. Never open any enclosure when power is connected to the system or its components.



CAUTION

The exclamation point icon indicates a situation or condition that may lead to equipment malfunction or damage. Do not proceed until the caution message is read and thoroughly understood. Caution messages are shown in bold type.



NOTE

The note icon indicates additional or supplementary information about the action, activity or concept. Notes are shown in bold type.

CAUTION

HIGH FORCES ARE OFTEN INVOLVED WITH THE MATERIAL TESTING PROCESSES.

THE PRODUCT IS NORMALLY USED UNDER BATTERY POWER. HOWEVER, MAINS POWER MAY BE USED.

IF THE EQUIPMENT IS USED IN A MANNER NOT SPECIFIED BY THE MANUFACTURER, THE PROTECTION PROVIDED BY THE EQUIPMENT MAY BE IMPAIRED.

TO MAINTAIN ALL ASPECTS OF THE SPECIFICATION, ONLY AMETEK® APPROVED ACCESSORIES, CONNECTIONS AND COMPONENTS SHOULD BE USED.

STRICTLY ADHERE TO ALL SPECIFIED SAFETY PROCEDURES

READ THIS MANUAL BEFORE USING THIS PRODUCT.

General Safety

General safety precautions must be followed when using this Chatillon® product. Failure to observe precautions and warnings may result in damage to the equipment, or injury to personnel.

It is understood that safety rules within companies vary. If a conflict exists between the material contained in all Chatillon® User's Guides and the rules of a company using a Chatillon® product, the more stringent rules should take precedence.

Safety Considerations

The DF II Series is completely enclosed and provides no potentially hazardous outputs. Safety considerations are related to the power connections and physical mountings.

Electronic and mechanical components housed within the DF II Series covers are to be serviced by authorized Chatillon® representatives only.



When designing custom fixtures ensure the load rating of the custom fixtures exceed the load rating of the load cell in the force gauge being used. i.e. If the load cell is rated for 100 LBF the custom fixtures should have a load rating greater than 100 LBF.

TABLE OF CONTENTS

Getting started	6	Selecting low limit setpoint	35
Test stand adapters	8	Viewing load limit result	35
Powering gauge on/off	9	Using auto shutdown	36
Charging your gauge	9	Selecting time period	36
Keypad operation	10	Activating auto shutdown	36
Display layout	11	About gauge communications	37
Display options	11	USB Communication Set-up	37
Changing display options	12	Setup - Communications	37
Display up or down option	12	Selecting limits	38
Display backlight option	12	Selecting baud rate	38
Display hide option	13	Pinouts	39
Auto dimming	13	Using hyperterminal commands	40
Display peaks	13	Changing gauge polarity	41
Languages	13	Setup - Polarity	41
Changing mode	14	Connecting a printer	42
Zero and taring mode	14	Communication cables	42
Changing units	15	Connecting a serial printer	43
Units lock	15	Connecting a mitutoyo printer	43
Load bar graph	16	Using remote sensors	44
Sensor overload protection	16	SLC loadcell sensors	44
Sensor overload display	16	STS torque sensors	44
Password protection	16	Specifying the correct sensor	45
Operating your gauge	17	Understanding full scale capacity	45
Handheld operation	17	Accuracy error effects	45
Test stand operation	17	Powering your gauge	46
Affixing adapters & fixtures	17	Connecting a sensor	46
Saving results	18	Power up with STS sensor	46
Clear saved data	18	Improper sensor connection	46
Viewing results	19	About SLC sensors	47
Viewing active result	19	Inserting the SLC sensor	47
Viewing pass-fail results	20	Handling the SLC sensor	48
Graphing of results	21	Mounting SLC sensor to tester	49
Transmit results	22	Using software	50
Transmit displayed result	22	Using load averaging	51
Transmit format	23	Load average force-based	51
Clear result from memory	25	Load average time-based	51
Using pass-fail limits	26	Load average setup	52
Activating pass-fail limits	28	Load average - select type	52
Select pass-fail method	28	Selecting increments	52
Selecting increments	29	Selecting preload limit	53
Selecting high range limit	29	Selecting time limit	53
Selecting low range limit	30	Performing a force-based load average test	54
Select nominal value method	30	Performing a time-based load average test	55
Select nominal value	31	Test annunciators	55
Select bandwidth	31	Using break detection	56
Using load limits	32	Sharp break	57
Load limit buzzer	32	Percentage break	57
Activating transmit limits	33	Break detection setup	58
Selecting increments	34	Break detect - select type	58
Selecting high limit setpoint	34	Selecting increments	58

TABLE OF CONTENTS

Selecting break point	59
Selecting % drop value.....	60
Performing a sharp break test.....	61
Performing a percentage break test	62
Viewing your break test result	63
Transmitting your break test result	63
Saving your break test result.....	65
Applying statistics to your break test result .	66
View % difference.....	67
Using filters.....	68
Display filter.....	68
Peak filter.....	68
Filter setup.....	68
Display filter setup.....	69
Peak filter setup.....	69
Using contact closure.....	70
Contact closure operation.....	71
Contact closure mode.....	71
Contact closure pass-fail	71
Contact closure setup.....	72
Contact closure - on/off	73
Contact closure - open type.....	73
Contact closure - close type	73
Specifications	74
Features and functions	74
Dimensions.....	75

1.0 GETTING STARTED



CAUTION: The load cell sensor used in your DF II Series gauge is temperature sensitive. The gauge should be turned On and allowed to acclimate to ambient temperature before normal use and before being calibrated.

A 5 minute "warm-up" period is recommended.

The Chatillon® DF II Series digital force gauges are battery powered precision instruments used to measure axial tensile or compressive forces.

The following models represent the DF II Series force gauges:

- DFE II Series (With Outputs)
- DFS II Series (Integral Loadcell)
- DFS II-R Series (Dedicated Remote Loadcell)
- DFS II-R-ND Series (Interchangeable Sensor)
 - SLC Series (Loadcell Sensor)
 - STS Series (Torque Sensor)



NOTE: The functions and features described in this user's guide may not be available on all DF II models.

Please read this operating manual thoroughly before attempting to operate your gauge.

The tables below identify the standard accessories that were supplied with your DF II Series digital force gauge.

DF II Series Standard Accessories by Model

DFE II Series

Carrying Case	SPK-DF-118
Flat Adapter ¹	SPK-FMG-011A
	SPK-FMG-011B
Hook ¹	SPK-FMG-012A
	SPK-FMG-012B
	SPK-FMG-012C
Chisel Point ¹	SPK-FMG-008A
	SPK-FMG-008B
Point ¹	SPK-FMG-009A
	SPK-FMG-009B
Notch Adapter ¹	SPK-FMG-010A
	SPK-FMG-010B
Extension Rod ¹	SPK-FMG-013A
	SPK-FMG-013B
Charger	SPK-DF2-UNIV
RS232 Cable	SPK-DF-RS232
Calibration Certificate	

DFS II Series

Carrying Case	SPK-DF-118
Flat Adapter ¹	SPK-FMG-011A
	SPK-FMG-011B
Hook ¹	SPK-FMG-012A
	SPK-FMG-012B
	SPK-FMG-012C
Chisel Point ¹	SPK-FMG-008A
	SPK-FMG-008B
Point ¹	SPK-FMG-009A
	SPK-FMG-009B
Notch Adapter ¹	SPK-FMG-010A
	SPK-FMG-010B
Extension Rod ¹	SPK-FMG-013A
	SPK-FMG-013B
Charger	SPK-DF2-UNIV
RS232 Cable	SPK-DF-RS232
Calibration Certificate	

DFS II-R Series

Carrying Case	SPK-DF-118
Flat Adapter ¹	SPK-FMG-011A
	SPK-FMG-011B
Hook ¹	SPK-FMG-012A
	SPK-FMG-012B
	SPK-FMG-012C
Charger	SPK-DF2-UNIV
RS232 Cable	SPK-DF-RS232
Calibration Certificate	

DFS II-R-ND Series

Carrying Case	SPK-DF-118
Charger	SPK-DF2-UNIV
RS232 Cable	SPK-DF-RS232
Calibration Certificate	

SLC Series

Carrying Case	SPK-DF-118
Flat Adapter ¹	SPK-FMG-011A
	SPK-FMG-011B
Hook ¹	SPK-FMG-012A
	SPK-FMG-012B
	SPK-FMG-012C
Male Adapter	NC000296
Calibration Certificate	

STS Series

Carrying Case	SPK-DF-118
Hex Blade	SPK-DTG-040
Hex Drive 1/4	SPK-DTG-037 ²
Hex Drive 3/8	SPK-DTG-038 ²
Hex Drive 1/2	SPK-DTG-039
Calibration Certificate	

NOTE:

¹ Accessories are capacity dependent. Accessories used with capacities below 110 lbf (500N) will generally have a #10-32 thread. Accessories for higher capacities generally have a 5/16-18 thread.

² Accessories are capacity dependent. Accessories used with low torque capacity (3-50 in-lb) will receive 1/4 and 3/8 Hex Drive. Larger capacities receive 3/8 and 1/2 Drives.

TEST STAND ADAPTERS

The following tables show the proper adapters required when mounting your DF II Series force gauge to a Chatillon® force tester.

Low Capacity
110 lbf (500N) and below

High Capacity
Above 110 lbf (500N)

DF II Series		DF II Series	
MT150	SPK-MT-0001	MT150	SPK-MT-0004
MT500	SPK-MT-0001	MT500	SPK-MT-0004
LTCM-100	Direct Connect	LTCM-100	Direct Connect
TT Tester	NC002582	TT Tester	NC002582



Shown: DFS II digital force gauge mounted on the LTCM-100 motorized tester.

POWERING GAUGE ON/OFF

The DF II Series gauge has a dedicated power key. Depress the key to turn the gauge On or Off.

When the gauge is turned on, the Chatillon® Splash Screen is displayed for approximately 5 seconds. This display shows the gauge model and capacity, firmware revision level, revision date and website address for downloads.



Shown: The power On/Off button is located on the front of all DF II Series force gauges.



NOTE: New NiMh batteries need to be charged 3-5 times before they will hold a full charge. This doesn't mean charged 3-5 times in a row, but rather, charged 3-5 cycles under normal use.

CHARGING YOUR GAUGE

The DF II Series contains a Nickle Metal Hydride (NiMh) Battery Pack that can provide up to 20 hours of continuous use on a single charge.

A Battery icon appears on the main operating display and operates like a bar graph. When the gauge has a full charge, the Battery icon appears full and is green. As battery power diminishes, the Battery icon will "open" and as power drains, it will turn yellow to indicate a lower level of charge.

You may view battery life remaining, by depressing the "i" key. The gauge will display the estimated battery life based on current usage in hours.

Dimming	Hours of use
ON	20 hours
OFF	16 hours
ON	16 hours
OFF	12 hours

The DF II Series gauge will alert you when the battery requires charging. The gauge will display "Re-charge Required" and the battery icon will show as "opened" and red.

It is best to completely drain your battery before recharging. To recharge, plug the stereo jack connector into the top housing. Plug the charger/adaptor into your source power. Charge for 15-20 hrs to achieve maximum performance. A thermistor is used to prevent excessive heat from damaging the battery pack.

The DF II Series has a universal 120/230V power supply.



KEYPAD OPERATION

The DF II Series gauge has nine (9) keys and a navigation pod.

Function Keys

There are three (3) function keys located immediately below the gauge display. These keys are mapped to the display prompt above it. Key functions change based on the gauge's current status or operating mode. If no prompt appears above the key, the key is inactive.

Navigation Pod

The navigation pod is primarily used during setup. This circular pod contains four (4) directional arrows that correspond to certain gauge functions. The UP and RIGHT arrows are used to increment numbers or to navigate in an upward direction or to the right. The DOWN and LEFT arrows are used to decrement numbers or to navigate in a downward direction or to the left.

UNITS Key

A dedicated UNITS key is used to change the units of measure.

ZERO Key

A dedicated ZERO key is used to zero a measured result or to tare the weight of attachments and fixtures prior to measuring a load.

HOME Key

A dedicated HOME key is used to return you to the main operating display.

ENTER Key

A dedicated ENTER key is used to enable a selection or to accept a result.

Power Key

A dedicated POWER key is used to turn gauge power ON or OFF.

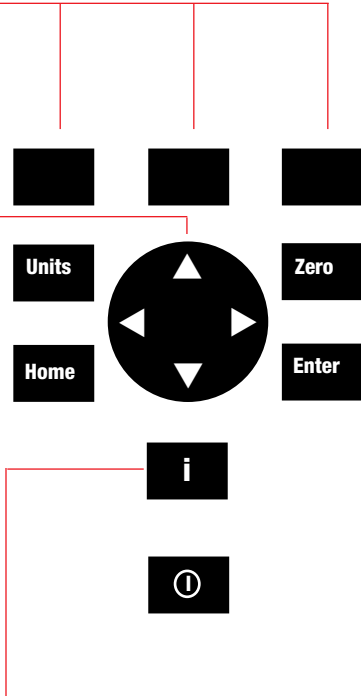

INFO Key

The INFO key provides you with "information" about your DF II Series force gauge. It is also used to review SAVED information that is stored in the gauge memory.

Depress the "i" key to access the following information:

- Gauge Capacity x Resolution
- Firmware Revision and Revision Date
- Overload History
- Battery Life
- Saved Results and Graph of Results

DISPLAY LAYOUT

The DF II Series digital force gauge features a TFT-LCD full-color display with backlight.

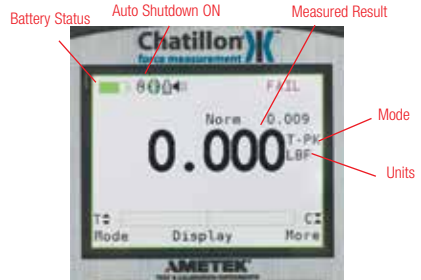

DISPLAY OPTIONS

The DF II Series gauge features the following display options designed to enhance operation and performance.

- Display Up or Down
- Display Backlight
- Hide Result

Display Up Down

This function operates in normal operating mode only. It allows you to display information rightside up or upside down using the navigation pod.

Display Backlight

This function operates in either normal operating mode or setup mode. It allows you to adjust the display backlight lighter or darker depending on your lighting conditions.

Hide Result

This function operates in normal operating mode only. It allows you to "hide" your results during a test. The "hide" function is useful for blind study applications. Selecting the right or left arrow on the navigation pod toggles the displayed result on/off.

To access and change display options, select the HOME key to place the gauge in normal operation. Select the F2 DISPLAY key.

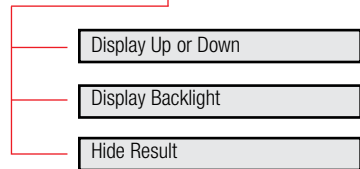

Display Options Menu



NOTE: The brighter the setting on the backlight, the shorter battery life.

CHANGING DISPLAY OPTIONS

From HOME display, select F2 DISPLAY key. This places the gauge in DISPLAY SETUP MODE.

DISPLAY UP OR DOWN OPTION

The Display Up or Down option allows you to change the orientation of the display.

From HOME display, select F2 DISPLAY key. The status line will read "Display Up Down". If the status line displays "ON", the "Display Up Down" option is enabled.

To change the orientation, depress the F1 key (On or OFF).

If the "Display Up Down" option is ON, displayed information is presented upside down. The function keys map to the function tags.

If the "Display Up Down" option is OFF, the feature is disabled. The gauge displays information rightside up.



NOTE: The Display Up or Down option only functions when the gauge is in the normal operating mode. It does not operate in the setup modes.

DISPLAY BACKLIGHT OPTION

The Display Backlight option allows you to change the backlight level of the display. This may be useful in low or high light ambient environments and to save battery life.

The DISPLAY BACKLIGHT is the second option in the display setup mode.

From the DISPLAY UP DOWN screen, depress the F3 DISPLAY key until "Display Backlight" appears on the status line.

Depress the F1 HIGH key or F2 LOW key to change the backlight level of brightness.

Selecting HIGH brightens the backlight setting.

Selecting LOW darkens the backlight setting.

DISPLAY HIDE OPTION

The Display HIDE option allows you to hide your measured result during testing. This feature is useful when performing blind studies.

From the DISPLAY BACKLIGHT screen, depress the F3 DISPLAY key until "Hide Result" appears on the status line.

Depress the F1 (NO or Yes) key to enable the Hide Result option.

Selecting YES allows you to use the navigation pod to hide your measured result.

Use the LEFT arrow to "Hide" your force value.

Use the RIGHT arrow to "Unhide" your force value.

Selecting NO disables the Hide Result option.



AUTO DIMMING

The Auto dimming function is preset from the factory to maximize battery life. The DF II Series of gauges is set such that the LCD Backlight will automatically dim if there is no use of the unit within 30 seconds. The user can disable this setting and also manually brighten the display.

To change the setting:

- Press F3 (More) four times. Scroll down to Auto Dimming and press Enter.
- Press the F1 (Off) key to disable.
- To enable, follow the same instructions as above with the F1 (On) key used to enable the function.



WARNING: Disabling Auto Dimming will result in a reduction in battery life.

DISPLAY PEAKS

The Display Peaks function is preset from the factory to show the peak values. The user can disable this setting.

To change the setting:

- Press F3 (More) four times. Scroll down to Display Peaks and press Enter.
- Press the F1 (Off) key to disable.
- To enable, follow the same instructions as above with the F1 (On) key used to enable the function.

LANGUAGES

The DF II Series of gauges contains the programming to allow for the unit to display in English, French, German, Spanish, Portuguese, and Chinese. To change the language displayed on the unit:

- Press the F3 (More) key five times.
- The Select Language function is the only function on this screen. Press Enter.
- Use the Navigation Pod Up/Down arrows to change the language selection. Once the desired language is displayed on the unit, press Enter to select that language.



CAUTION: If the language has been changed on the unit inadvertently, the user should press the Home key, the F3 key five times, and then Enter. The user can then use the Up/Down arrows to select a readable language.

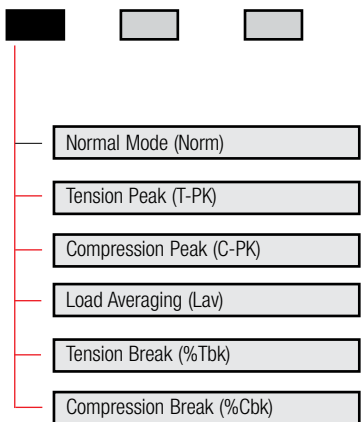

CHANGING MODE

You may change the DF II Series gauge operating mode by selecting the F1 (Mode) key. From the HOME display, select F1 (Mode) for the following operating modes:

Normal Mode

When the gauge is in normal mode (NORM), the display will indicate the tensile or compressive load that is applied to the loadcell.

Peak Tension Mode

When the gauge is in Peak Tension mode (T-PK), the gauge will display the maximum tensile load that was measured by the loadcell sensor.

Peak Compression Mode

When the gauge is in Peak Compression mode (C-PK), the gauge will display the maximum compressive load that was measured by the loadcell sensor.



NOTE: Load averaging, Tension break and Compression break are explained later in the manual.



NOTE: The DF II Series force gauge allows you to save results to memory for the purposes of calculating statistics. Therefore, you cannot change mode if you have results saved in memory. **You must clear results from the instrument's memory before you are allowed to change the mode.**



ZERO AND TARING GAUGE

The DF II Series gauge has a dedicated ZERO key for zeroing the measured result or for taring out the weight of accessories, grips or fixtures attached to your gauge. Your gauge is capable of taring up to 10% of its specified capacity.

To zero a result or tare, depress the ZERO key.

To zero or CLEAR stored values in memory, please see Stored Values section.

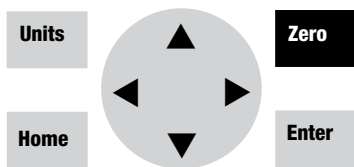

i



CHANGING UNITS

The DF II Series gauge has a dedicated UNITS key for changing units of measure.

DF II Series gauges with a capacity of 110 lbf (500N) and below can display results in the following units: ozf, gf, lbf, kgf and N.

DF II Series with capacities greater than 110 lbf (500N) can display results in lbf, kgf and N.

DFS II-R-ND gauges with the STS Series torque sensor can display torque in the following units: N-cm, cm-kg, oz-in, lb-in, N-m.

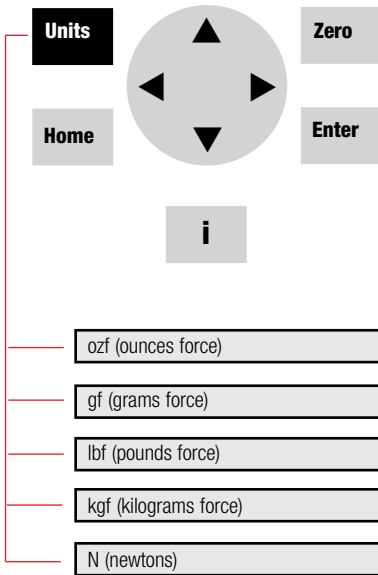

The ozf and gf units are available on DF II Series gauges with capacities of 100 lbf and below. These units are not available on 200 lbf or higher capacities.

UNITS LOCK

You may "lock" the units of measured on your DF II Series gauges. This disables the UNITS key.

To enable the UNITS LOCK feature, from HOME, select the F3 (More) key to get to the SETUP function. From Home, depress the F3 key four times.

Select Units Lock. Select ENTER. Use the F1 key to turn the feature ON/OFF.

A "Lock Icon" appears at the top of the screen when the Units Lock feature is ON. A message prompt also alerts the operator.



LOAD BAR GRAPH

The DF II Series gauge features a dynamic bar graph that shows the force or torque being applied to the gauge.

The purpose of the bar graph is to provide a visual indicator to the user when they are approaching the sensor's capacity.

The bar graph has a "T" for tension and a "C" for compression to indicate direction of force. The bar graph fills from the centerline and changes from green to yellow to red indicating proximity to the sensor's capacity. If the DFS II-R-ND uses the STS torque sensor, the bar graph will change to show "CW" for clockwise and "CCW" for counter-clockwise.



SENSOR OVERLOAD PROTECTION

The DF II Series gauge features mechanical overload protection up to 150% of the sensor's capacity.

Mechanical overload protection is provided in the tension and compression direction for sensors with a capacity of 110 lbf (500N) and below.

SENSOR OVERLOAD DISPLAY

When the DF II Series gauge senses that the force applied is approximately 116% of the sensor capacity, the bar graph will fill and the lower message line will display "OVERLOAD".

PASSWORD PROTECTION

The DF II Series offers Password Protection for the unit set-up. The Password feature may be accessed by:

- Pressing F3 (More) four times, scrolling down to select Password Enable, then pressing Enter. The Status will show if the function is On or Off.
- If Off, Press the F1 key (On) to enable the Password protection. Once enabled, the user will need to know the password to change the Mode, Peak Values, etc. on the unit.
- If the user attempts to change a protected parameter, the unit will prompt for a password to be entered. The password is entered using the Navigation Pod (Up/Down Arrows to increment or decrement value and Left/Right arrows to select the digit). The Factory Default value is "0000".
- Once the digits are entered, The Enter key is pressed to allow for changes to the unit.
- The user also is prompted to use the Home key to exit if the Password is not known.
- To change the Password, from the Password screen, hold the Zero key for 5 seconds and a message will show to enter the new password.



NOTE: Green load bar graph to 75% of capacity. Yellow load bar graph from 75% to 90% of capacity. Red load bar graph greater than 90% of capacity.



CAUTION: If OVERLOAD is displayed, you may have damaged the sensor.

CAUTION: The bargraph provides you with visual indication on the amount of force or torque being applied to the load cell sensor or torque sensor. Use caution when applying loads and torque. If the bargraph is nearly filled and is red, stop applying load or torque to prevent damage to your sensor.

OPERATING YOUR GAUGE

The DF II Series gauge may be used as a handheld instrument or mounted to a Chatillon® tester for compression and tensile testing.



CAUTION: The DF II Series gauge is designed for axial loading only. Never apply a side load to the load shaft.

HANDHELD OPERATION

When using the DF II Series gauge for handheld testing, make sure to apply the load axially to the load shaft.

Keep the gauge perpendicular to the item being measured to ensure axial loading. Use the optional handle assembly (SPK-DF-HANDLE) for high capacity loads.



TEST STAND OPERATION

When using the DF II Series gauge with a Chatillon® tester, make sure that the gauge is secured to the tester with the proper adapter if required. Adapters may be required to ensure that the gauge shaft is located axially to the sample under test. If the gauge is not secured properly, you may get faulty reading or cause damage to the loadcell.



DFS II gauge mounted to LTCM100 tester

Low Capacity
110 lbf (500N) and below

High Capacity
Above 110 lbf (500N)

DF II Series		DF II Series	
MT150	SPK-MT-0001	MT150	SPK-MT-0004
MT500	SPK-MT-0001	MT500	SPK-MT-0004
LTCM-100	Direct Connect	LTCM-100	Direct Connect
TT Tester	NC002582	TT Tester	NC002582

AFFIXING ADAPTERS & FIXTURES

Adapters and test fixtures should be mated to the load shaft on the instrument. Do not use tools to secure your adapters or fixtures. Finger torque tightness is sufficient.



CAUTION: Do not use hand tools to secure adapters or fixtures to your gauge. Over tightening will damage the sensor.

Secure fixtures and adapters with "finger-tight" torque.

SAVING RESULTS

The DF II Series can save 20 or 100 results (depending on model) in the gauge memory. You may use our TCD WEDGE software (p/n NC003164-D) to save infinite results and perform automation, data acquisition and detailed measurement analysis.

To save a result, apply load to the loadcell shaft. Your gauge will display the load reading.



To save, select the F3 (More) key. This will take you to the View display. Select F2 (Save).

If you do not want to save a result, select the Zero key. This will zero the gauge and clear the result.



NOTE: The DF II Series force gauge allows you to save results to memory for the purposes of calculating statistics. Therefore, you cannot change mode if you have results saved in memory. **You must clear results from the instrument's memory before you are allowed to change the mode.**

To change MODE, you must clear all Saved Data from the gauge's memory. This is to ensure that the gauge will correctly calculate statistics, since results from different modes will cause erroneous statistics.



CLEAR SAVED DATA

To change MODE, you must clear all Saved Data from the gauge's memory. This is to ensure that the gauge will correctly calculate statistics, since results from different modes will cause erroneous statistics.

In DF II Series gauges the following message prompts the user to clear saved data:

"MODE [locked] CLR SAVED DATA"

VIEWING RESULTS

The DF II Series displays results in the following formats:

- Active Measured Result
- Saved Measured Result(s)
- Pass - Fail Result
- Load Limit Result
- Load Average Result
- Break Detect Result (DFS II Series only)

VIEWING ACTIVE RESULT

The DF II Series gauge will display the result in Normal, Tension Peak (T-PK) or Compression Peak (C-PK) modes.

The DF II Series gauge will display the measured result, mode, units of measure, active options and battery life.

Displaying Normal Mode Result

When the DF II Series gauge is in Normal mode, the gauge will indicate the measured result, units, active options, Tpk, Cpk and battery life. Select the F1 (Mode) key to set the gauge in Normal mode.

When in Normal mode, the gauge will display the load that is currently being applied to the load sensor. A compressive load is indicated as a "positive" result. A tensile load is indicated as a "negative" (-) result. The load bar graph will also indicate the load and direction of load that is applied to the sensor relative to the sensor's capacity. The loadcell bar graph is intended to assist you in preventing overloads. If the bar graph is nearly filled and is red, you should stop applying a load to the sensor. See Load Bar Graph.

Displaying Peak Mode Result

If you want your DF II Series gauge to display the peak result, you should change the gauge to either Tension Peak (T-PK) or Compression Peak (C-PK) depending on the direction you are testing. Peak results will also show in the standard mode screen.



NOTE: If you perform a test in NORMAL mode and you want to view what the peak measurement was they are displayed above and below the current active reading. You may also select the Mode key and the gauge will display the peak result even if the test was performed in NORMAL mode.

Viewing Saved Result

The DFE II will save up to 20 and the DFS II will save up to 100 measured results in its internal memory provided you elect to "SAVE" a result.

To view a "Saved Result", from the Home display, select F3 (More) to access the View display. Select the "INFO" key (i).

Saved results are displayed with their reference number (1 of 100, 2 of 100, etc.). The measured value, units and mode are displayed. Use the navigation pod UP and DOWN arrow to view the remaining saved results from memory.

A graphical representation of the results can also be viewed by selecting F3 (More) key while viewing a result. To exit the graph and return to viewing results, select F3 (More)



VIEWING PASS-FAIL RESULTS

Pass-Fail results are viewed from the View display. To access the View display from the Home display, select the F3 (More) key.

Saved results are displayed with their reference number (1 of 100, 2 of 100, etc.) and indication of green "Pass" or red "Fail" based on your specifications. The measured value, units and mode are displayed with a green "Pass" or red "Fail" tag. Use the navigation pod UP and DOWN arrow to view the remaining saved results from memory.

When "PASS-FAIL" is enabled (ON), the gauge will display a green "PASS" or red "FAIL" two ways:

1. If the gauge MODE is either T-PK or C-PK;
2. If measured results are SAVED into memory.



Viewing Pass-Fail for Peak Results

If "PASS-FAIL" is enabled (ON), the gauge will indicate a green "PASS" or red "FAIL" result when a peak result is displayed. The gauge will also display either the High and Low Limits or the Nominal Value and Bandwidth %. The gauge will NOT display a "PASS" or "FAIL" for normal mode results.

Viewing Pass-Fail Results from Memory

If "PASS-FAIL" is enabled (ON), the results saved in memory are tagged with either a green "PASS" or a red "FAIL" based on the "PASS-FAIL" setup.

VIEW results by using the navigation pod UP and DOWN key to scroll through the results saved in memory. If "PASS-FAIL" is enabled, each result will be tagged with a green "PASS" or red "FAIL".

You may XMIT or CLEAR the displayed result by selecting either the XMIT (F1) key or the CLEAR (F2) key. Select the MORE (F3) key to calculate statistics.



To view "PASS-FAIL" results, start from the HOME display. Select F3 (MORE) and then the INFO key. If it is desired to clear all of the values, instead of using the F2 (Clear) function, select the Zero key. A message will appear on the screen advising to Press Enter to Clear All.



NOTE: You can apply Pass/Fail tolerances to your results in memory after they have been saved. It is not necessary to apply a tolerance prior to saving a result.



NOTE: You must enable the Pass/Fail feature before you can view a Pass/Fail result.

GRAPHING OF RESULTS

The DFS II is capable of displaying a graphical representation of the saved results. To view the graph, enter into the viewing of saved results (press F3 to see the number of saved results, then press i to see a particular result) then from the saved result screen, press F3 (More) to view the graph of all saved results.



TRANSMIT RESULTS

The DF II Series can transmit data using its RS232, Mitutoyo, USB, or Analog output. The gauge will transmit data to whatever device is connected to the gauge through the selected output port.

Data transmit is used to send information to another device, e.g. personal computer or to print information to a serial or Mitutoyo printer.

To transmit information, the gauge must be in the View display.

You have two options when transmitting:

- Transmit Displayed Result
- Transmit ALL Results from Memory



TRANSMIT DISPLAYED RESULT

You can transmit results from the View display. From Home, select F3 (More). This will access the View display.

Select F1 (Xmit) to specify what you want to transmit. You may transmit either the displayed result or all results saved in instrument memory.

Select F1 (Xmit-W or Xmit-O) to transmit the currently displayed result. If "Xmit-W" is displayed, the gauge has been setup to transmit WITH UNITS. If "Xmit-O" is displayed, the gauge has been setup to transmit the result WITHOUT UNITS. You specify the output type in the Communication Setup procedure.

Select F1 (Xmit) to transmit all currently saved results from the instrument memory. The gauge will transmit all results With or Without Units as defined by the F1 key. If the F1 key says "Xmit-W", all results will be transmitted WITH UNITS. If the F1 key says "Xmit-O", all results will be transmitted WITHOUT UNITS.



TRANSMIT FORMAT

The DF II Series gauge will transmit and print results in the following formats:

Transmit WITH UNITS (Xmit-W)

Mode	Result	Value	Units
Norm 1		3.8	lb
Norm 2		3.8	lb
Norm 3		3.7	lb
Norm 4		4.3	lb
Norm 5		4.1	lb
Norm 6		3.8	lb
Norm 7		4.0	lb
Norm 8		3.5	lb
Norm 9		3.9	lb
Norm 10		4.5	lb
Mean		4.0	
S-DEV		0.3	
COV		7.13	
Variance		0.1	
% Diff			
1 v 2		0.00	
2 v 3		-2.68	
3 v 4		14.83	
4 v 5		-4.20	
5 v 6		-7.21	
6 v 7		4.05	
7 v 8		-12.66	
8 v 9		12.64	
9 v 10		13.86	

Transmit WITHOUT UNITS (Xmit-O)

Mode	Result	Value
Norm 1		3.8
Norm 2		3.8
Norm 3		3.7
Norm 4		4.3
Norm 5		4.1
Norm 6		3.8
Norm 7		4.0
Norm 8		3.5
Norm 9		3.9
Norm 10		4.5
Mean		4.0
S-DEV		0.3
COV		7.13
Variance		0.1
% Diff		
1 v 2		0.00
2 v 3		-2.68
3 v 4		14.83
4 v 5		-4.20
5 v 6		-7.21
6 v 7		4.05
7 v 8		-12.66
8 v 9		12.64
9 v 10		13.86

Transmit WITHOUT UNITS (Xmit-O)



Gauge will transmit result WITHOUT units.

The gauge can transmit information with or without units.

If the F1 label indicates “Xmit-O”, the gauge will transmit data withOut units.

You can select how you want data to be transmitted at the COMMUNICATION SETUP MENU.

Transmit WITH UNITS (Xmit-W)



Gauge will transmit result WITH units.

If the F1 label indicates “Xmit-W”, the gauge will transmit data With units.

Analog Output

The DF II Series gauge supplies a $\pm 2\text{Vdc}$ ($\pm 0.015\text{Vdc}$) analog output. The output is a linear signal with a 200Hz frequency. The analog output may be used to drive annunciators, recorders or other external devices.

Transmit Using RS232

The DF II Series gauge will communicate to a serial device using its RS232 output. Connect to the device using the RS232 cable (p/n SPK-DF-RS232).

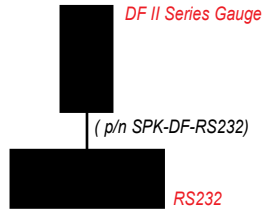

Transmit Using USB

The DF II Series gauge will communicate to a serial device using its USB output. Connect to the device using the USB cable (p/n SPK-FMG-USB).

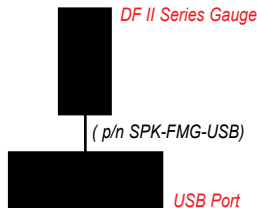

Transmit Using Mitutoyo

The DF II Series gauge will communicate to a Mitutoyo device when configured with the Mitutoyo output. Connect to the device using the Mitutoyo cable (p/n NC000654).

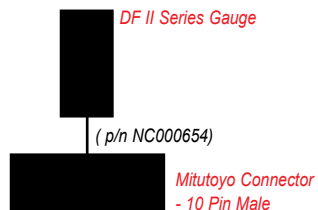

CLEAR RESULT FROM MEMORY

The DFS II can store up to 100 and the DFE II can store up to 20 results in instrument memory. These results may be used for later viewing or for calculating statistics.

You may clear a result using the View display.

To access the View display from the Home display, press the F3 (More) key once. This will access the View display.

To access the CLEAR option, select the INFO key (i key). This will change the F2 (Save) key to F2 (Clear). Select F2 (Clear) to clear the displayed result. Use the UP and DOWN key to access the remaining stored results for clearing. A message will show on the DF display stating to Clear the selected result, press Enter.

You may Clear all results from the same menu by selecting Zero instead of the F2 (Clear) feature. The DF will display a message saying to Clear all results, press Enter.



USING PASS-FAIL LIMITS

The DF II Series force gauge allows you to setup PASS-FAIL LIMITS based on either a Range of values or on a Nominal Value.

Pass-Fail Limit - Range

You may setup your DF II Series gauge to display a green PASS or red FAIL message based on whether or not the measured results falls within an upper and lower setpoint range. The gauge will display green PASS or red FAIL depending on how the measured result compares to the setpoint range.

Example: The DF II Series will display green PASS if the measured result is 11.2 lbf and the upper setpoint was 12.0 lbf and the lower setpoint was 10.0 lbf.

Conversely, if the measured result was 9.8 lbf, the gauge would display red FAIL.

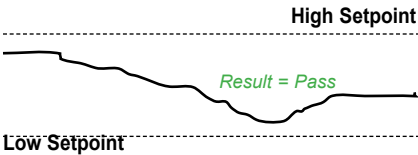

If the measured result is equal to or within the Range Limits, the result = PASS.

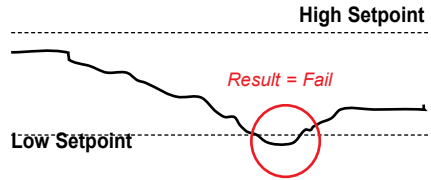

If the measured result is outside the Range Limits, the result = FAIL.



USING PASS-FAIL LIMITS

The DFS II Series allows you to setup PASS-FAIL LIMITS based on either a Range of values or on a Nominal Value.

Pass-Fail Limit - Nominal Value

You may setup your DFS II Series gauge to display a green PASS or red FAIL message based on whether or not the measured results falls within an upper and lower setpoint range calculated using a Nominal Value and % Bandwidth. The gauge will display green PASS or red FAIL depending on how the measured result compares to the setpoint range.

Example: The DFS II Series will display green PASS if the measured result is 9.8 lbf and the Nominal Value was 10.0 lbf and the Bandwidth is 10%.

Conversely, if the measured result was 8.9 lbf, the gauge would display red FAIL.

High Setpoint

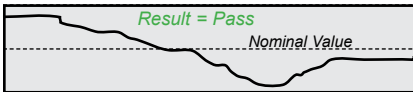

Low Setpoint

If the measured result is equal to or within the range calculated by the nominal value and user-specified bandwidth %, the result = PASS.

High Setpoint

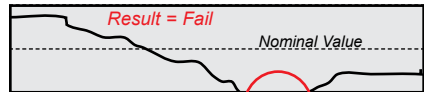

Low Setpoint

If the measured result is outside the range calculated by the nominal value and user-specified bandwidth %, the result = FAIL.



ACTIVATING PASS-FAIL LIMITS

You have the option of enabling or disabling Pass-Fail Limits. The factory default is Pass-Fail Limits OFF.

To enable Pass-Fail Limits, from the Home display, select F3 (More) twice. This will take you to the Main Setup Menu display.

Use the navigation UP or DOWN key to position the cursor arrow next to the PASS - FAIL option. Select enter.

The Pass-Fail activation display allows you to "turn ON" or "turn OFF" the Pass-Fail feature. Select F1 to turn ON or OFF. Select enter.

SELECT PASS - FAIL METHOD

There are two Pass-Fail Methods available to choose from:

- Range
- Nominal Value

Use the navigation pod UP and DOWN key to position the cursor arrow next to the method you want to base your Pass-Fail result on. Select ENTER.

SELECT RANGE METHOD

Use the navigation pod UP and DOWN key to position the cursor arrow next to the RANGE method. Select ENTER.

SELECTING INCREMENTS

Increments are associated with the numeric values displayed by the gauge during setup. You select the increment you want to use to adjust your setup values. Increments are provided in values corresponding to the gauge capacity and units of measure. Increment values available are:

- 0.001
- 0.01
- 0.1
- 1.0
- 10.0
- 100.0

Selecting an increment of 10.0 will adjust the setup numeric value by “tens”. Selecting the increment 0.1 will adjust the setup numeric value by “tenths”.

You select increments using the RIGHT and LEFT arrow keys on the navigation pod. Selecting the RIGHT arrow increases the increment value. Selecting the LEFT arrow decreases the increment value.

SELECTING HIGH RANGE LIMIT

Use the F1 key to select the HIGH RANGE Pass-Fail Limit. The cursor arrow will automatically be placed next to the HIGH Limit tag indicating that you are about to adjust this value.

Use the UP and DOWN navigation key to increase or decrease the High Pass-Fail Limit VALUE. The value will increase by the increment selected upon each key press.

Do NOT select ENTER until you have adjusted both the High and Low Pass-Fail Limits to your desired setpoints.

SELECTING LOW RANGE LIMIT

Use the F1 key to select the LOW RANGE Pass-Fail Limit. The cursor arrow will automatically be placed next to the LOW Limit tag indicating that you are about to adjust this value.

Use the UP and DOWN navigation key to increase or decrease the Low Pass-Fail Limit VALUE. The value will increase by the increment selected upon each key press.

Select enter when you have adjusted both the High and Low Pass-Fail Limits to your desired setpoints.

SELECT NOMINAL VALUE METHOD

Use the navigation pod UP and DOWN key to position the cursor arrow next to the NOMINAL VALUE method. Select ENTER.

The Nominal Value method uses a specified set-point value and bandwidth to calculate the High and Low setpoints. The DF gauge will automatically calculate and display the High and Low Limits. You only need to specify the Nominal Value and the % Bandwidth.

SELECTING INCREMENTS

Increments are associated with the numeric values displayed by the gauge during setup. You select the increment you want to use to adjust your setup values. Increments are provided in values corresponding to the gauge capacity and units of measure. Increment values available are:

- 0.001
- 0.01
- 0.1
- 1.0
- 10.0
- 100.0

Selecting an increment of 10.0 will adjust the setup numeric value by "tens". Selecting the increment 0.1 will adjust the setup numeric value by "tenths".

You select increments using the RIGHT and LEFT arrow keys on the navigation pod. Selecting the RIGHT arrow increases the increment value. Selecting the LEFT arrow decreases the increment value.

SELECT NOMINAL VALUE

Use the F1 key to specify the Nominal Value or the Bandwidth. When Pass-Fail is ON, the gauge will start at the Nominal Value position.

Use the UP and DOWN navigation key to increase or decrease the Nominal Value. The value will increase by the increment selected upon each key press. Note that the gauge will automatically calculate the High and Low Limits based on the Nominal Value entered and the Bandwidth value.

SELECT BANDWIDTH

Use the F1 key to specify the Bandwidth. the Bandwidth is expressed as a percentage of the Nominal Value. The maximum allowable bandwidth is 50%.

Use the UP and DOWN navigation key to increase or decrease the Bandwidth. The value will increase by the increment selected upon each key press. Note that the gauge will automatically calculate the High and Low Limits based on the Bandwidth entered and the Nominal value.

Select enter when you are satisfied with your calculated limits based on your Nominal Value and Bandwidth.

USING LOAD LIMITS

The DF II Series force gauge allows you to setup and apply LOAD LIMITS. You may setup HIGH and LOW load limits. Load Limits are useful for protecting your gauge or testing system from damage or to simply alert you that the gauge or system has exceeded a setpoint value.

LOAD LIMIT BUZZER

You may setup your DF II Series gauge to provide an audible alarm whenever a Load Limit has been reached. When the buzzer is enabled, an icon will show in the main display.



If the measured result falls below the LOW setpoint, the gauge will display "L-LO" until the result is greater than the LOW setpoint value.



If the measured result exceeds the HIGH setpoint, the gauge will display "L-HI" until the result is less than the HIGH setpoint value.

ACTIVATING TRANSMIT LIMITS

You have the option of enabling or disabling Transmit Limits. The factory default is Transmit Limits OFF.

To enable Transmit Limits, from the Home display, select F3 (More) twice. This will take you to the Main Setup Menu display.

Use the navigation UP or DOWN key to position the cursor arrow next to the COMMUNICATIONS option. Select enter.

The XMIT LIMITS option is used to activate the Transmit Limits feature. Use the RIGHT arrow to activate the Transmit Limits (ON). Use the LEFT arrow to deactivate the Transmit Limits (OFF).

When Transmit Limits are ON, the DF II Series gauge will transmit a continuous data string to the attached TCD Series tester through the RS232 port.

When a High Limit is reached, the DF II Series gauge will send a continuous string of “\$\$\$\$\$” to the tester. The tester will read this string and stop the crosshead from traveling.

When a Low Limit is reached, the DF II Series gauge will send a continuous string of “*****” to the tester. The tester will read this string and stop the crosshead from traveling.

Activating Buzzer

You have the option of enabling or disabling the Load Limits Buzzer. If ON, the Buzzer provides you with a visual indicator and an audible indicator when the load measurement exceeds a High or Low Load Limit.

The buzzer icon is displayed when this feature is turned ON.



Select the F2 (B-ON) to turn the Buzzer feature ON. Or select F2 (B-OFF) to turn the Buzzer feature OFF.

SELECTING INCREMENTS

Increments are associated with the numeric values displayed by the gauge during setup. You select the increment you want to use to adjust your setup values. Increments are provided in values corresponding to the gauge capacity and units of measure. Increment values available are:

- 0.001
- 0.01
- 0.1
- 1.0
- 10.0
- 100.0

Selecting an increment of 10.0 will adjust the setup numeric value by “tens”. Selecting the increment 0.1 will adjust the setup numeric value by “tenths”.

You select increments using the RIGHT and LEFT arrow keys on the navigation pod. Selecting the RIGHT arrow increases the increment value. Selecting the LEFT arrow decreases the increment value.

SELECTING HIGH LIMIT SETPOINT

The HIGH Limit Setpoint is the load value representing the highest COMPRESSION load value that you want your gauge to measure prior to it giving a Load Limit indication. The HIGH Load Limit is a positive number or zero.

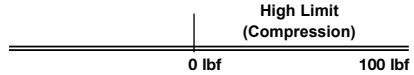

Use the F1 key to select the HIGH Load Limit. The cursor arrow will automatically be placed next to the HIGH Load Limit tag indicating that you are about to adjust this value.

Use the UP and DOWN navigation key to increase or decrease the High Load Limit VALUE. The value will increase by the increment selected upon each key press.

Do NOT select enter until you have adjusted both the High and Low Limits to your desired setpoints.

SELECTING LOW LIMIT SETPOINT

The LOW Limit Setpoint is the load value representing the lowest TENSION load value that you want your gauge to measure prior to it giving a Load Limit indication. The LOW Load Limit is a negative number or zero.

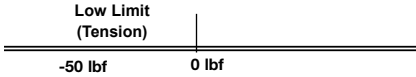

Use the F1 key to select the LOW Load Limit. The cursor arrow will automatically be placed next to the LOW Load Limit tag indicating that you are about to adjust this value.

Use the UP and DOWN navigation key to increase or decrease the Low Load Limit VALUE. The value will increase by the increment selected upon each key press.

Select enter after both the High and Low Limits have been adjusted.

VIEWING LOAD LIMIT RESULT

The DF II Series gauge will display "L-T" if a Low Load (Tension) Limit has been reached, or "L-C" if a High Load (Compression) Limit has been reached. The Limit tag displays until the measured result falls above or below the user-specified limit.

Load Limit indications are displayed in any mode.

USING AUTO SHUTDOWN

The DF II Series force gauge allows you to configure your gauge to automatically shut down if there has been no keypad activity or no communication activity for a specified period of time. The purpose of automatic shutdown is to help preserve the instrument battery. The factory default for Auto Shutdown is OFF (disabled).

If your tests involve long test periods where keypad entries are infrequent, you should take care to specify a long shutdown period to avoid losing testing results. Or, consider NOT using the automatic shutdown feature.

The DF II Series gauge can be specified to automatically shutdown when there has been no keypad activity or communication activity from 10 minutes up to 480 minutes (8 hours).

SELECTING TIME PERIOD

Automatic Shutdown time is expressed in MINUTES.

Use the UP and DOWN key to select the desired time period, e.g. the amount of time in minutes that determine that the gauge will automatically shutdown when there has been no keypad activity.

Each depress of the UP or DOWN key increments the time by 10 minutes.

ACTIVATING AUTO SHUTDOWN

Automatic Shutdown may be activated from the Main Setup display. From the Home display, select the F3 (More) key twice to access the Main Setup display.

Use the UP and DOWN navigation keys to position the cursor arrow next to the Auto Shutdown tag. Select enter.

Select the F1 key to turn Auto Shutdown ON or OFF



Auto Shutdown Icon. Indicates that the automatic shutdown feature is activated.



If Mitutoyo communications are enabled, all other communication features and outputs are disabled. If communications are not working, verify that Mitutoyo is not enabled.

ABOUT GAUGE COMMUNICATIONS

The DF II Series force gauges allow you to communicate to external devices using either RS232, Mitutoyo, USB, or analog outputs.

Communication may be via the 12-pin output using the following Chatillon® cables:

- RS232 (Cable p/n SPK-DF-RS232)
- Mitutoyo (Cable p/n NC000654)

The ± 2 Vdc analog output is always available via pins 11 and 12.

Communications via the USB output is through the USB port.

- USB (Cable p/n SPK-FMG-USB)

USB COMMUNICATION SET-UP

If the computer does not recognize the DF2 force gauge as a USB device please run the executable file contained on the user manual CD named "DF2_Drivers.exe". These drivers will allow the computer to properly communicate with the Chatillon DF2 force gauge via the USB port. To verify the USB connection is set up properly between the computer and the Chatillon DF2 force gauge go "Control Panel", "Hardware and Sound", "Device Manager", "Ports (COM & LPT)". You can ensure the USB connection is set up properly and what COM port the computer assigned to it.

Note: When using RS232 or USB communication please ensure that the Mitutoyo communication is set to the "OFF" setting (disabled). If the Mitutoyo communication is set to "ON" (enabled), the Chatillon DF2 force gauge disables all other RS232 or USB communications.

SETUP - COMMUNICATIONS

Communications may be setup from the Main Setup display. From the Home display, select the F3 (More) key twice to access the Main Setup display.

Use the UP and DOWN navigation keys to position the cursor arrow next to the Communications tag. Select enter.

You may then set the Xmit Units, Xmit Limits, Baud.

Use the F2 (More) function to move to the next screen and select the communication method. The default factory setting is RS232. Use the UP and DOWN navigation keys or the F1 (Change) to change selections to USB Port.

Use the F2 (More) function to move to the screen to select a protocol for the DF II Series.

The DF II Series has a standard AMETEK® protocol and an Alternate protocol loaded for use of the ASCII commands. Use the UP and DOWN navigation keys or the F1 (Change) to change selection.

SELECTING LIMITS (RS232 AND USB)

The DF II Series allows you to transmit an ASCII signal when a Load Limit has been met. This signal is used to stop crosshead movement on a TCD Series tester.

A HIGH LIMIT sends the following ASCII string:

\$\$\$\$\$\$\$\$

A LOW LIMIT sends the following ASCII string:

To enable XMIT LIMITS, position the arrow next to the XMIT LIMITS tag. Select the RIGHT arrow on the navigation key to enable this feature (ON). Select the LEFT arrow on the navigation key to disable this feature (OFF). Select ENTER.

SELECTING BAUD RATE (RS232)

The DF II Series allows you to select the required baud rate when in RS232 mode.

Position the arrow next to the BAUD tag. Use the UP and DOWN arrow to specify any of the following baud rates:

- 4800
- 9600
- 19200
- 28800
- 38400
- 57600
- 115200

Select ENTER to enable.

PINOUTS

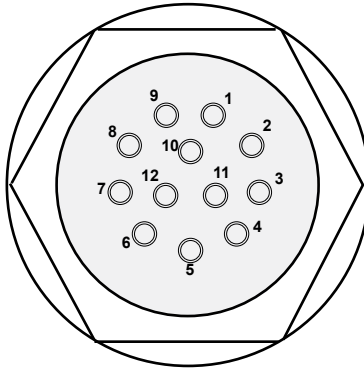

The DF II Series is supplied with a 12-pin female connector to provide RS232, Mitutoyo and analog outputs. The pinout of the connector is shown above. Pin assignments are defined in the table below.

PIN	SYMBOL	I/O	PURPOSE	DESCRIPTION
1	TXD	O	RS-232	Transmitted Data
2	RXD	I	RS-232	Received Data
3	GND	O	Ground	Digital Ground
4		O	Clock	Mitutoyo Clock
5		O	Ready	Mitutoyo Ready
6		I	Request	Mitutoyo Request
7		O	Data	Mitutoyo Data
8		I	Detect	Sense Contact Closure
9		O	Setpoint	Setpoint Output Signal
10		-	Ground	Digital Ground
11		-	Analog GND	Analog Ground
12		O	Analog SIG	Analog Output

USING HYPERTERMINAL COMMANDS

The *DF II Series* can accept and execute commands through the RS232 or USB communications using Hyperterminal. The command set is tailored to make it easy to configure and operate the instrument under a computer program control. The string commands are sent as strings of ASCII characters. The following string commands are recognized:

Command	Response	Description
F		Toggles between Normal and Data Collect Modes
P		Steps through Peak Modes: Normal, Tension Peak, Compression Peak
R		Resets the gauge: zeroes all modes.
S	^N-MODE^^^<CR><LF> or TP-MODE^^^<CR><LF> or CP-MODE^^^<CR><LF>	Sends currently selected mode: Normal, Tension Peak, Compression Peak, Data Collect
U		Steps through Units
X or ?	±99.999^lb<CR><LF> or ±9999.9^kg<CR><LF> or ±99.999^N<CR><LF> ±99.999^oz<CR><LF> or ±9999.9^g<CR><LF> or ±99.999^N^<CR><LF> ERROR^^^<CR><LF> overload.	Sends data on display with the position of the decimal place the same as on display. If "Transmit Limits" is set to transmit without units ^ is replaced by ^^. Response during force
Y		Opens RS232 output and sends continuous data stream when in Data Collect mode.
Z		Zeroes the currently selected mode: Normal, Tension Peak or Compression Peak

CHANGING GAUGE POLARITY

The *DF II Series* will normally display TENSION measurements as a NEGATIVE number, while displaying COMPRESSION measurements as a POSITIVE number.

However, you may change the gauge so that it displays tensile results as POSITIVE number and compression results as a NEGATIVE.

SETUP - POLARITY

Polarity may be setup from the Main Setup display. From the Home display, select the F3 (More) key twice to access the Main Setup display.

Use the UP and DOWN navigation keys to position the cursor arrow next to the Communications tag. Select enter.

The F1 key indicates the current polarity for the gauge results:

C +ve means the compression result will display as a POSITIVE number (ve = voltage excitation). This is the gauge default setting

T +ve means the tension result will display as a POSITIVE number.

To change the polarity, depress the F1 key. Select ENTER.

CONNECTING A PRINTER

The DF II Series force gauge can transmit information to a serial data printer or Mitutoyo printer. Printing is performed from the View display using the TRANSMIT function.

From the Home display, select F3 (More) to access the View Display.

Select F1 (Xmit) to access the Transmit display. From this display, you have the options of transmitting the current displayed result, or transmitting all results saved in the instrument memory. Selecting the Xmit keys will send data through the gauge's output, in the configured format, to the external device.

See Communications for the output setup options.

COMMUNICATION CABLES

The DF II Series gauges are supplied standard with an RS232 serial data cable (p/n SPK-DF-RS232). You may also use the outputs on these gauges to communicate with Mitutoyo devices. A USB cable is also available.

Connect to	Cable
Serial Device	SPK-DF-RS232
Mitutoyo Device	NC000654



CONNECTING A SERIAL PRINTER

Connect the DF II Series gauge to the serial printer using the gauge output connector and the serial cable provided with the gauge (p/n SPK-DF-RS232). The serial data cable has a Hirose connector for the gauge and a D-Type 9-Pin male connector for the printer.

Configure the gauge outputs (See Using Outputs) and match the baud rate in the gauge to the baud rate for the printer.

CONNECTING A MITUTOYO PRINTER

Connect the DF II Series gauge to a Mitutoyo printer using the optional Mitutoyo cable (p/n NC000654). The Mitutoyo cable is a 10-pin connector cable with a Hirose connector for the gauge and a 10-pin male connector for the printer.

Configure the gauge output type to MITUTOYO. The gauge will transmit data with units to the Mitutoyo printer.

Read the manual that came with the Mitutoyo printer to determine the printer setup requirements.



NC000654

USING REMOTE SENSORS

The DFS II-R-ND Series digital force gauge can be used with two different types of sensors:

- SLC Loadcell Sensors
- STS Torque Sensors

SLC LOADCELL SENSORS

The SLC Series loadcell sensors have been designed to work exclusively with the DFS-R-ND and DFS II-R-ND Series force gauges. These sensors are NOT compatible with previous Chatillon® digital gauges that used interchangeable sensors. The SLC Sensor is inserted into the 15-pin connector located on the side of the DFS II-R-ND gauge. The gauge will automatically recognize the sensor type and its associated capacity and resolutions.

The SLC Series sensor is available in capacities from 250gf to 1000 lbf. Multiple sensors can be used to mount to a single DFS II-R-ND gauge. This can provide the user with cost savings and convenience. The disadvantage is the DFS II-R-ND with remote sensors has an accuracy of better than 0.25% full scale (compared to a dedicated sensor with accuracy of better than 0.1% full scale).

The flexible cable used with the SLC sensors are ideal for applications where access to the sample under test is limited. The cable, when fully extended, reaches approximately 9 feet (3 meters).



STS TORQUE SENSORS

The STS Series torque sensors have been designed to work exclusively with the DFS-R-ND and DFS II-R-ND Series force gauges. These sensors are NOT compatible with previous Chatillon® digital gauges that used interchangeable sensors. The STS Sensor is inserted into the 15-pin connector located on the side of the DFS II-R-ND gauge. The gauge will automatically recognize the sensor type and its associated capacity and resolutions.

The STS Series sensor is available in capacities from 3 in-lbs to 200 in-lbs. Different capacity sensors may be plugged into the DFS II-R-ND depending on the application requirements. The gauge's automatic recognition eliminates the need to configure the capacities and resolution.

The STS Series sensors come with different hex fittings for attaching to the test sample. The STS sensor is turned and the gauge will indicate torque and torque direction. The cable, when fully extended, reaches approximately 9 feet (3 meters).



SPECIFYING THE CORRECT SENSOR

The single, most-common problem when measuring load or torque is caused by the use of a sensor that is not appropriate for the application.

The sensor selected should be specified so that the expected measured results occurs within the 20% to 90% capacity for the sensor. This is particularly important when using “full scale accuracy” devices. Operating at too near either end of the sensor’s capacity can lead to inaccurate measurements, and worse, a damaged sensor.

The table below indicates the recommended sensor capacities for different test applications.

Sensor Selection Guide

Expected Load	Recommended Capacity	Model
50 - 225 gf	250 gf	SLC-250G
500 gf - 1.8 lbf	2 lbf	SLC-0002
2 - 9 lbf	10 lbf	SLC-0010
10 - 22.5 lbf	25 lbf	SLC-0025
10 - 45 lbf	50 lbf	SLC-0050
20 - 90 lbf	100 lbf	SLC-0100
40 - 180 lbf	200 lbf	SLC-0200
100 - 450 lbf	500 lbf	SLC-0500
200 - 900 lbf	1000 lbf	SLC-1000
10 - 45 in-oz	3 in-lb	STS-0003
2 - 10.8 in-lb	12 in-lb	STS-0012
10 - 45 in-lb	50 in-lb	STS-0050
20 - 90 in-lb	100 in-lb	STS-0100
40 - 180 in-lb	200 in-lb	STS-0200

UNDERSTANDING FULL SCALE CAPACITY

The SLC and STS Series sensors have accuracies based on “full scale”. The accuracy of these sensors is based on the full scale capacity of the sensor.

If the sensor capacity is 100 lbf, and the accuracy is $\pm 0.25\%$ of full scale, there will be more measurement error effect at the lower end of the capacity. In some instances, if too high a capacity sensor is used, and the measurement is too near the zero (under 10%), the measured results may indeed be inaccurate, e.g. using a 100 lbf loadcell to measure a 10 lbf load.

ACCURACY ERROR EFFECTS

Load	Min	Max	% Error
0	0	0.25	100%
2	1.75	2.25	25%
5	4.75	5.25	10%
10	9.75	10.25	5%
25	24.75	25.25	2%
50	49.75	50.25	1%
100	99.75	100.25	0.5%

Example: Assumes a 100 lbf (500N) load sensor with an accuracy of $\pm 0.25\%$ full scale.

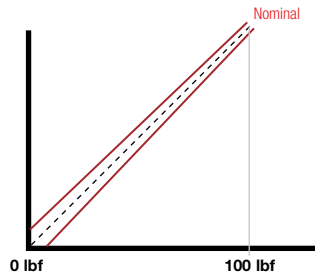

Example: The diagram shows the accuracy limits of a 100 lbf sensor with an accuracy specification of better than 0.25% full scale. The further the measured result from capacity, the more error is introduced. The effects of using an improper loadcell capacity on too low a measurement will increase the error in measured result.

POWERING YOUR GAUGE

The DFS II-R-ND requires a sensor for it to perform as a force or torque gauge. The DFS II-R-ND without a sensor attached will indicate that a sensor must be fitted.

If an SLC or STS sensor is not connected to the gauge, the gauge will display "Int Cal Error", "Ext Cal Error", "Configuration Error", "Defaults loaded" or "No Sensor".

The gauge will then ask for a Calibration Date. Power down the gauge and connect the sensor to allow for a proper instrument start,



CONNECTING A SENSOR

The SLC or STS Sensor must be connected to the DFS II-R-ND gauge with the power OFF. The gauge does not permit "hot swapping" of sensors, connecting new sensor with the power ON. The DFS II-R-ND must go through the power ON routine with the sensor attached so that it can obtain the sensor characteristics. The sensor characteristics, e.g. sensitivity, calibration data, etc. is stored on a printed circuit board in the connector for the sensor.

POWER UP WITH STS SENSOR

When you connect a calibrated STS Sensor to the DFS II-R-ND, the gauge will display the STS model number, representing the capacity on the power up display. The gauge will perform as a torque gauge.

IMPROPER SENSOR CONNECTION

If you disconnect the sensor from the gauge with power still ON, the gauge will display "No Sensor".

If you connect a new sensor to the DFS II-R-ND with power still ON, the gauge will display the last sensor that was recognized at power up. It will not recognize the new sensor, since the sensor's characteristics are transmitted to the gauge firmware at powerup. If the last sensor that was attached to the gauge before powering down was an SLC-0100, and you connect an SLC-0025 with power still ON, the gauge will perform incorrectly and act as if the SLC-0100 is connected.

ABOUT SLC SENSORS

The SLC Series sensor may be used for tensile or compression testing. The “S” type sensors have one end dedicated for tension and the other end dedicated for compression. It is important, when using this type of sensor, to ensure that the proper end of the sensor is being used.

INSERTING THE SLC SENSOR

The SLC Sensor mates to the DFS II-R-ND using a 15-pin connector. The connector on the SLC is equipped with a PCB that helps the DFS II-R-ND recognize the sensor characteristics.

With the DFS II-R-ND turned OFF, insert the SLC connector making sure to properly “seat” the individual pins. Once the sensor is connected, secure the sensor by tightening the mounting screws. Do NOT over-tighten. Finger-tight torque is sufficient.

Turn the DFS II-R-ND ON. The gauge will display the sensor capacity and resolutions for all available units of measure.

If no sensor is connected, if an incompatible sensor is applied, or if the sensor is damaged, the DFS II-R-ND gauge will display “No Sensor”.



Carefully mate the connector on the SLC or STS sensor to the connector on the side of the DFS II-R-ND gauge.



CAUTION: Never connect or disconnect a remote sensor when power to the gauge is On.



CAUTION: Do not over-tighten fixtures onto a sensor. Finger-tight torque is sufficient. Over-tightening can damage the sensor, especially on low capacity sensors.

HANDLING THE SLC SENSOR

The SLC Sensor is a precision instrument.

HANDLE WITH CARE and follow these precautions:

PRECAUTIONS

- **Do not connect the sensor when the power to the DFS II-R-ND is ON.** Make sure that power to the DFS II-R-ND is OFF before connecting your sensor.
- **Do not disconnect the sensor by pulling on the cable.** Grasp the connector and pull the sensor from the DFS II-R-ND gauge.
- **Do not carry the sensor using the cable.** This may damage the internal wiring of the sensor.
- **Make sure to use the proper end of the “S” type sensors.** One end is dedicated to “tension”. One end is dedicated to “compression”.
- **Use the proper capacity for your testing.** Ideally, make sure that the expected measured load falls within the 20% to 80% range of the sensor capacity.
- **Never connect an incompatible sensor.** Use only SLC Series or STS Series sensors.
- **Store your sensor properly.** When not in use, store your SLC sensor in its original carrying case.



NEVER disconnect the sensor by pulling on the cable. This may damage connections. Disconnect by grasping the connector and pulling from the connector housing.



For a tensile test, fix the tensile adapter at the end opposite the “Dead Side”. Connect the “Dead Side” to the tester.

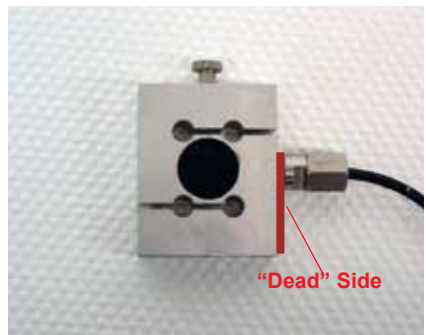

For a compression test, fix the compression adapter at the end opposite the “Dead Side”. Connect the “Dead Side” to the tester.

MOUNTING SLC SENSOR TO TESTER

The SLC Series loadcell sensor may be used with Chatillon® force testers. A mounting adapter is required to secure the sensor to the following testers:

Tester	Adapter Part No.
MT150	SPK-MT-0001 & NC000300
MT500	SPK-MT-0004 & NC000300 ¹
LTCM-100	NC000300
TT Tester	NC002582 & NC000300 ¹

Note: NC000300 CANNOT be used on tests requiring a capacity greater than 225 lbf (1 kN).

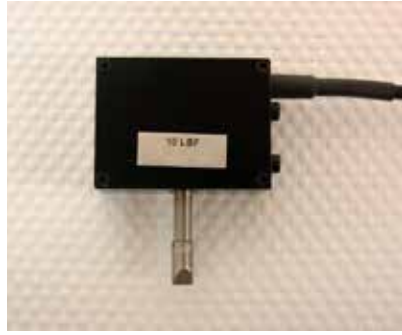

SLC Sensors with capacities of 10 lbf (5N) and less, have a "block-style" design. Higher capacity loadcell sensors have an "S-type" design.

SLC SENSOR CAPACITIES

SLC Model	ozf	gf	lbf	kgf	N
SLC-250G	8 x 0.002	250 x 0.05	0.5 x 0.0001	0.25 x 0.0001	2.5 x 0.0005
SLC-0002	32 x 0.005	1000 x 0.1	2 x 0.0002	1 x 0.0001	10 x 0.001
SLC-0010	160 x 0.02	5000 x 0.5	10 x 0.001	5 x 0.0005	50 x 0.005
SLC-0025	400 x 0.05	10,000 x 1	25 x 0.002	10 x 0.001	100 x 0.01
SLC-0050	800 x 0.1	25,000 x 2	50 x 0.005	25 x 0.002	250 x 0.02
SLC-0100	1600 x 0.2	50,000 x 5	100 x 0.01	50 x 0.005	500 x 0.05
SLC-0200	-	-	200 x 0.02	100 x 0.01	1000 x 0.1
SLC-0500	-	-	500 x 0.05	250 x 0.02	2500 x 0.2
SLC-1000	-	-	1000 x 0.1	500 x 0.05	5000 x 0.5

STS SENSOR CAPACITIES

STS Model	oz-in	N-cm	lb-in	kg-cm	N-m
STS-0003	50 x 0.005	35 x 0.005	3 x 0.0005	3.5 x 0.0005	0.35 x 0.0001
STS-0012	192 x 0.02	125 x 0.02	12 x 0.002	12.5 x 0.002	1.25 x 0.0002
STS-0050	800 x 0.1	500 x 0.05	50 x 0.005	50 x 0.005	5 x 0.0005
STS-0100	-	1000 x 0.1	100 x 0.01	100 x 0.01	10 x 0.001
STS-0200	-	2000 x 0.2	200 x 0.02	200 x 0.02	20 x 0.002

USING SOFTWARE

Your DF II Series gauge can be operated using our applications software:

- NEXYGEN DF2
- ForceTest

Specific software information is available on demand.

USING LOAD AVERAGING

The DF II Series force gauge allows you to perform two different types of Load Averaging tests:

- Load Average Force-Based
- Load Average Time-Based

LOAD AVERAGE FORCE-BASED

This load averaging test allows you to set a preload limit value or load threshold. This gauge mode is represented and displayed as "LAVF". The preload value represents the "Start" and "End" point for your averaging function. The gauge will begin to collect and average the measured values once the "Preload Value" has been sensed. The gauge will continue to average until the measured load drops below the preload value. When the test is completed, the gauge will display the "Average Load". You can also display the peak load for the averaging period by selecting the F1 mode key.



LOAD AVERAGE TIME-BASED

This load averaging test works identical to the Force-Based method except it adds "Time" as a factor. You may set the "Time Value" from 1 second to 999 seconds. This gauge mode is represented and displayed as "LAVT".

The gauge will begin to collect and average the measured values once the "Preload Value" has been sensed. The gauge will continue to average until the measured load drops below the preload value OR until the specified time has expired. When the test is completed, the gauge will display the "Average Load". You can also display the peak load for the averaging period by selecting the F1 mode key.

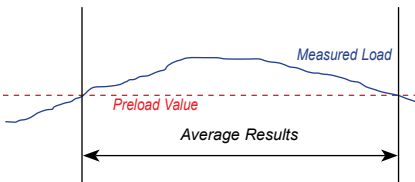

The gauge will begin to average once the preload value is reached. The gauge will continue to average until the measured load drops below the preload value.

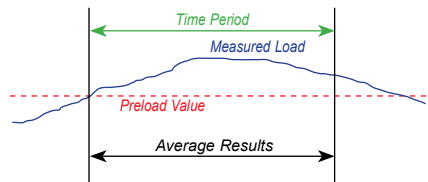

The gauge will begin to average once the preload value is reached. The gauge will continue to average until the measured load drops below the preload value or when the time has expired.

LOAD AVERAGE SETUP

To setup the Load Average function, from the Home display depress F3 (More) three times. Use the navigation key to position the arrow at the "Load Average" function. Press ENTER.

LOAD AVERAGE - SELECT TYPE

The DFS II load average default type is Load Average Force-Based. The setup menu will display the current Preload Value (PreL).

To change the Load Average type to Time-based, select the F1 (T-ON) key. The gauge will now display "Time". A cursor will appear next to the "Preload" value. Use the F1 key to toggle between the two available Load Average Types.

SELECTING INCREMENTS

Increments are associated with the numeric values displayed by the gauge during setup. You select the increment you want to use to adjust your setup values. Increments are provided in values corresponding to the gauge capacity and units of measure. Increment values available are:

- 0.001
- 0.01
- 0.1
- 1.0
- 10.0
- 100.0

Selecting an increment of 10.0 will adjust the setup numeric value by "tens". Selecting the increment 0.1 will adjust the setup numeric value by "tenths".

You select increments using the RIGHT and LEFT arrow keys on the navigation pod. Selecting the RIGHT arrow increases the increment value. Selecting the LEFT arrow decreases the increment value.

SELECTING PRELOAD LIMIT

The "Preload Value" is the threshold value or "trigger point" that defines the "Start" and "End" of the average function.

If the Preload Value is 5.00 lbf, the gauge will start to average once the load sensor has detected a 5.00 lbf load. The gauge will continue to average the load that is applied to the load sensor until the applied load drops below 5.00 lbf. Once the load drops below the preload value, the test is ended. The average is calculated and displayed.

Select the Preload Limit value by first adjusting your increments. Use the UP or DOWN navigation key to set the Preload Limit value. Depressing the DOWN key will decrease the displayed value. Depressing the UP key will increase the displayed value. Depress ENTER to select.

SELECTING TIME LIMIT

The "Time Value" functions with the "Preload Value". It represents the operand "OR" when selected. The gauge will "start" to average once the preload value is achieved. The gauge will continue to average until the load applied to the sensor drops below the preload value, OR, until the time period specified expires.

To select Time, you must first active the time function by pressing the F1 (T-ON) key. This enables the time function. When in the time function, you may disable by depressing the F1 (T-OFF) key.

Select the F2 (Time) key. This will reposition the cursor arrow next to the Time label.

Select the increment value using the LEFT or RIGHT navigation key. Increments for time may be either 1, 10 or 100 and represent seconds. Time is only displayed in seconds. If you are using minutes, you must convert to seconds. The maximum time allowable is 999 seconds (16.56 minutes).

Select the desired time interval using the UP and DOWN navigation keys. Use the UP key to increase the time value. Use the DOWN key to decrease the time value. Select ENTER.

Select the F1 (T-OFF) key to disable the Time function.

Select F2 (Preload) to reposition the cursor arrow to the "PreL" preload label, allowing you to adjust the preload value.

Select F3 (Back) to return to the Setup menu.

PERFORMING A FORCE-BASED LOAD AVERAGE TEST

From the Home display, depress the F1 (Mode) key until the gauge displays "LAVf" for mode. The "LAVf" label indicates that the gauge is setup to perform a Load Average test based on a force only (No time).



Apply load to the measurement sensor. Load should be applied in one direction only (tension or compression). The gauge will begin to display the changes in applied loads. Once the measured load equals the preload value, the gauge will begin to average the applied loads. When the applied load falls below the preload value specified, the display will "freeze". The gauge will display the LAVf result when in the LAVf mode. The user may also display the peak load (the maximum load that was applied during the averaging function) by pressing the F1 key until you display "T-PK" or "C-PK". At the completion of a test you may record the following:

- Minimum Load (equals Preload Value)
- Peak Load (equals T-PK or C-PK)
- Average Load (equals LAVf)

You may Transmit (F1), Save (F2) or perform Statistics (F3) by depressing the associated function key.

PERFORMING A TIME-BASED LOAD

AVERAGE TEST

From the Home display, depress the F1 (Mode) key until the gauge displays "LAVt" for mode. The "LAVt" label indicates that the gauge is setup to perform a Load Average test based on a preload limit and a time period.

Apply load to the measurement sensor. Load should be applied in one direction only (tension or compression). The gauge will begin to display the changes in applied loads. Once the measured load equals the preload value, the gauge will begin to average the applied loads. When the applied load falls below the preload value specified, or when the time set has expired, the display will "freeze". The gauge will display the LAVt result when in the LAVt mode. The user may also display the peak load (the maximum load that was applied during the averaging function) by pressing the F1 key until you display "T-PK" or "C-PK". At the completion of a test you may record the following:

- Minimum Load (equals Preload Value)
- Peak Load (equals T-PK or C-PK)
- Average Load (equals LAVf)

You may Transmit (F1), Save (F2) or perform Statistics (F3) by depressing the associated function key.

TEST ANNUNCIATORS

The Load Averaging feature employs three types of annunciators to:

1. Signal the START of your Test,
2. Signal the END of your Test,
3. Signal the FAILURE of a Test

Signal the START of a Test

A single beep will sound to signal the START of a test.

The START of a test is determined by the measured load achieving the Preload Value that you setup for the test.

Signal the END of a Test

A double beep will sound to signal the END of a test that is based on both a Preload Value and a Time Period.

When a Time-based test is being conducted, a double beep will annunciate when the time period for the test has been achieved.

Signal a FAILED Test

A rapid, triple beep will sound to alert you that the measured load dropped below the Preload Value *before* the Time Period was completed.

USING BREAK DETECTION (DFS II ONLY)

Break Detection is used when you want to capture the break load of a sample. This function is useful especially with samples that characteristically yield before they actually break. The Break Detect function provides you with the Peak Load and the Break Load.

The DFS II Series gauge will report the following as part of a Break Detect test:

- Break Load
- Break Point (Break Threshold)
- % Drop (used to calculate the Break Load from Maximum Load)

The Break Load is calculated as:

$$\text{Break Load} = (\text{Peak Load})(\% \text{ Drop})$$

The % Drop is a user-defined point that the gauge will use to determine the break load. The % Drop value is the percentage of the maximum load that the DFS measures that you define as the Break Load.

In some cases, the Peak Load is the Break Load. However, with samples that yield before breaking, the Break Load is often not the same as the Peak Load.

Example: If the maximum load was measured to be 100 lbf and the % Drop was setup as 80%, the gauge will define the Break Load as 80 lbf.

If the maximum load was measured to be 50 N and the % Drop was setup as 50%, the gauge will define the Break Load as 25 N ($50 \text{ N} \times 0.5 = 25 \text{ N}$).

The DFS II Series force gauge allows you to perform two different types of Break tests:

- Sharp Break Test (95% Drop Fixed)
- Percentage Drop (% Break) Test

A Sharp Break is defined as a 95% drop in measured load from the recorded maximum load. The 95% Drop is a preset and cannot be changed by the user. When the load drops to a value equal to 95% of the maximum load, the gauge will identify this point as the Break Load.

A Percentage Drop (% Break) is a user-defined drop in measured load after the maximum load. You may select the desired % Drop to be used to calculate the Break Load.

Noisy samples, such as adhesives or peel tests should be specified with a high % Drop and with the Peak Filter set at 10Hz. Setting the % Drop too low may cause the gauge to sense a break before a break actually occurs. Conversely, samples that are rigid may use a high % Drop value. However, rigid samples typically break at a value equal to the Peak Load.

SHARP BREAK

The Sharp Break test looks for a 95% Drop from the maximum load. In this test, you can determine the "Break Detect Point" which is the load that must first be achieved before the DFS II Series gauges begins to look for a 95% Drop in load. The "Break Detect Point" is sometimes referred to as the "load threshold" or "trigger load".

During a Sharp Break Test, the DFS II gauge will look for the Peak Load value and determine a "Sharp Break" when the measured load equals 95% of the Peak Load value.

When the DFS II Series gauge is in the "Sharp Break Mode" the mode indicator will display as "SCBk" for "Sharp Compressive Break". The DFS II mode indicator will display "STBk" for "Sharp Tension Break".

PERCENTAGE BREAK

The Percentage Break test allows you to specify the % Drop from the Peak Load. If you set the % Drop at 80%, the DFS II gauge will determine the Break Load when the measured load is 80% of the Peak Load value.

When the DFS II Series gauge is in the "% Break Mode", the mode indicator will display as "%CBk" for "% Compressive Break". The DFS II mode indicator will display "%TBk" for "% Tension Break".

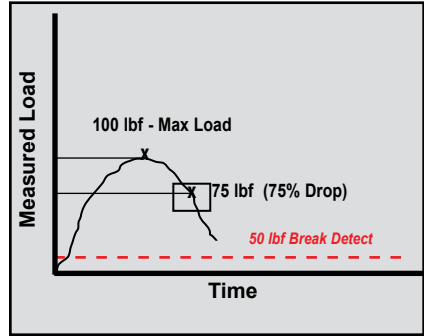
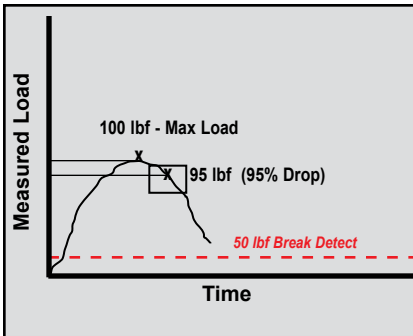

BREAK DETECTION SETUP

To setup the Break Detection function, from the Home display depress F3 (More) three times. Use the navigation key to position the arrow at the "Break Detect" function. Press ENTER.

BREAK DETECT - SELECT TYPE

The DFS II break detect default type is Percentage Break. To change the break detect type to Sharp Break, select the F1 (Sharp) key.

To change from Sharp Break to Percentage Break, select F1 (% Drop).

Results are expressed with the following mode labels:

- STBk (Sharp Break Tension)
- SCBK (Sharp Break Compression)
- %TBK (% Break Tension)
- %CBK (% Break Compression)

SELECTING INCREMENTS

Increments are associated with the numeric values displayed by the gauge during setup. You select the increment you want to use to adjust your setup values. Increments are provided in values corresponding to the gauge capacity and units of measure. Increment values available are:

- 0.001
- 0.01
- 0.1
- 1.0
- 10.0
- 100.0

Selecting an increment of 10.0 will adjust the setup numeric value by "tens". Selecting the increment 0.1 will adjust the setup numeric value by "tenths".

You select increments using the RIGHT and LEFT arrow keys on the navigation pod. Selecting the RIGHT arrow increases the increment value. Selecting the LEFT arrow decreases the increment value.

SELECTING BREAK POINT

The "Break Point" is the break detector value or the "break trigger". It is the force value that must be achieved before the gauge will look for the maximum load and the peak load.

It is important to set a correct "Break Point" based on the type of sample and the sample's break characteristics.

In a peel application, if the break point is set too low, the gauge may sense a break due to the characteristically noisy signal produced by a peel application. In a peel test, it is quite easy to have a 95% drop from a maximum load that is not representative of the true maximum load or true break load.

If the break point is set too high, the gauge may never see a break.

The best way to establish the break point is through sample testing trials.

Break Point - Sharp Break Method

To set the Break Point in a Sharp Break setup, establish the correct increment value. Use the UP navigation arrow to increase the Break Point value, and the DOWN navigation arrow to decrease the value. Select Enter once you have the desired Break Point value displayed.

Break Point - Percentage Break Method

To set the Break Point in a Percentage Break setup, establish the correct increment value. Position the arrow cursor next to the label "BkPt".

If the cursor arrow is next to the "%Bk" label, select the F2 (BkPt) key. This will reposition the cursor arrow next to the "BkPt" label.

Use the UP navigation arrow to increase the Break Point value, and the DOWN navigation arrow to decrease the value. Select Enter once you have the desired Break Point value displayed.

SELECTING % DROP VALUE

The "% Drop" is the percentage drop value. This represents how much the measured load must drop from a previous maximum load for the DFS II Series gauge to identify the break load.

A Sharp Break has a fixed percentage drop of 95%. It presents the 95% value from full scale. If the maximum load is 100 lbf and the % Drop is 95% (for a Sharp Break), the break load will be at 95 lbf. At 95 lbf, the DFS II gauge will "end the test". If the gauge is used with a TCD tester, the gauge will signal the tester at 95 lbf to stop the test.

A Percentage Break is a user-defined percentage drop. You may specify the % Drop to be from 1% to 99%.

To change the "% Drop" value, select the F2 (Percent) key. The cursor arrow will now point to the "%Drop" label.

Select the proper increments using the LEFT and RIGHT navigation arrows. The LEFT arrow decreases the increment value. The RIGHT arrow increases the increment value.

Use the UP arrow to increase the "%Drop" value. Use the DOWN arrow to decrease the "%Drop" value. Select Enter when the required % drop value is displayed.

PERFORMING A SHARP BREAK TEST

Once you have setup your Break Detect, from the Home display, depress the F1 (Mode) key until the DFS II displays "Norm".

Pull to Break

A pull to break test will use the mode "STBk". Affix your sample to the grip or fixture and zero the gauge. Press the Zero key to zero the load effects caused by the sample weight and fixture (tare out).

Pull the sample (manually or using a Chatillon® tester). The load applied to the load sensor is displayed during the test.

When the sample breaks (physically breaks) or when the load caused by the sample being pulled drops by 95% from a maximum value, the test will end.

You may view the Peak Load by pressing the F1 (Mode) key until the mode indicator displays "T-PK". The value displayed is the Peak Tensile value for the test. This value is taken from the DFS II Series gauge's Peak Register.

You may view the Break Load by depressing the F1 (Mode) key until the mode indicator displays "STBk". The DFS II Series gauge will display the following results and test parameters:

- 95% Drop (Sharp Break Default value)
- Break (Break Load) expressed as "STBk"
- Max (Maximum Load)

Compress to Rupture (Break)

A compress to rupture test will use the mode "SCBk". Affix your sample to the grip or fixture and zero the gauge. Press the Zero key to zero the load effects caused by the sample weight and fixture (tare out).

Compress (Push) the sample (manually or using a Chatillon® tester). The load applied to the load sensor is displayed during the test.

When the sample breaks (physically breaks) or when the load caused by the sample being pulled drops by 95% from a maximum value, the test will end.

You may view the Peak Load by pressing the F1 (Mode) key until the mode indicator displays "C-PK". The value displayed is the Peak Compression value for the test. This value is taken from the DFS II Series gauge's Peak Register.

You may view the Break Load by depressing the F1 (Mode) key until the mode indicator displays "SCBk". The DFS II Series gauge will display the following results and test parameters:

- 95% Drop (Sharp Break Default value)
- Break (Break Load) expressed as "SCBk"
- Max (Maximum Load)

PERFORMING A PERCENTAGE BREAK TEST

Once the Percentage Break Setup is complete, from the Home display, depress the F1 (Mode) key until the DFS II displays "Norm".

Pull to Break

A pull to break test will use the mode "%TBk". Affix your sample to the grip or fixture and zero the gauge. Press the Zero key to zero the load effects caused by the sample weight and fixture (tare out).

Pull the sample (manually or using a Chatillon® tester). The load applied to the load sensor is displayed during the test.

When the sample breaks (physically breaks) or when the load caused by the sample being pulled drops by your specified % Drop from a maximum value, the test will end.

You may view the Peak Load by pressing the F1 (Mode) key until the mode indicator displays "T-PK". The value displayed is the Peak Tensile value for the test. This value is taken from the DFS II Series gauge's Peak Register.

You may view the %Break Load by depressing the F1 (Mode) key until the mode indicator displays "%TBk". The DFS II Series gauge will display the following results and test parameters:

- % Drop (user-defined)
- Break (Break Load) expressed as "%TBk"
- Max (Maximum Load)

Compress to Rupture (Break)

A compress to rupture test will use the mode "%CBk". Affix your sample to the grip or fixture and zero the gauge. Press the Zero key to zero the load effects caused by the sample weight and fixture (tare out).

Compress (Push) the sample (manually or using a Chatillon® tester). The load applied to the load sensor is displayed during the test.

When the sample breaks (physically breaks) or when the load caused by the sample being pulled drops by 95% from a maximum value, the test will end.

You may view the Peak Load by pressing the F1 (Mode) key until the mode indicator displays "C-PK". The value displayed is the Peak Compression value for the test. This value is taken from the DFS II Series gauge's Peak Register.

You may view the Break Load by depressing the F1 (Mode) key until the mode indicator displays "%CBk". The DFS II Series gauge will display the following results and test parameters:

- % Drop (user-defined)
- Break (Break Load) expressed as "%CBk"
- Max (Maximum Load)



VIEWING YOUR BREAK TEST RESULT

The DFS II Series gauge will display the following information at the completion of a test:

From this display, you may record your reading manually; zero your test and start another, or navigate to the SAVE Mode. The SAVE Mode allows you to "Save" the result to the gauge memory or "Transmit" the value to an external device through the gauge's RS232, USB or Mitutoyo output.

To Zero the result, depress the Zero key. The result is erased from the gauge.

To go to the SAVE Mode, select the F3 (More) key.

TRANSMITTING YOUR BREAK TEST RESULT

From the SAVE Mode, select the F1 (Xmit) key to transmit information through the DFS II Series RS232 or USB communication port. When you select the F1 (Xmit) key you will be provided with two options:

- Xmit-W (F1)
- XmitAll (F2)



The F1 "Xmit-W" key will transmit the currently displayed value for %CBk mode through the DFS II gauge's digital output port. The following information is transmitted:

- Break Load with Units (%TBk,%CBk, STBk, SCBk)
- Maximum Load with Units
- % Drop Value
- Break Point Value
- Peak Register Value (T-PK, C-PK)
- Pass/Fail (if configured)
- Pass/Fail Limits (if configured)

The "Xmit-W" represents that the values will be transmitted "With" units. You may elect to transmit values without units by changing the Transmit option in the COMMUNICATIONS setup. Change the "Xmit Units" from "ON" to "OFF". When "Off", the gauge will transmit information without units. The F1 key will display "Xmit-O", the values will be transmitted without units.

When the F2 "XmitAll" key is selected, the gauge will transmit all information "Saved" in the gauge memory for the %Bk mode. The following information is transmitted:

- Result Number (1- 10)
- Break Load with or without Units
- Maximum Load with or without Units
- Peak Load with or without Units
- % Drop Value
- Break Point Value
- Pass or Fail Result
- Pass/Fail High Limit
- Pass/Fail Low Limit

Information will be transmitted in a Row format. Each Row will represent the Result Number. Column headers will be transmitted for each result value listed above.

Result	Break Load	Max Load	Peak Load	%Drop	BkPt	P/F	P/F High	P/F Low
1	25.00 lbf	50.00 lbf	53.48 lbf	50%	15 lbf	Pass	30.00 lbf	20.00 lbf

Sample Row Report

SAVING YOUR BREAK TEST RESULT

You may save up to 100 results in the DFS II Series gauge memory. If you are saving information, remember that the gauge can only save 100 results. It is also important for good operating practice to save like mode information. Don't mix different results from different modes.

From the SAVE Mode, select the F2 (Save) key to "save" information to the DFS II Series gauge's internal memory. Up to 100 results may be stored in memory. If larger numbers of results are required, you should use the Nexygen DF II Series Software.

The gauge will display the Result Number compared to the available results saved, e.g. "1 of 100 Saved".

If the memory is full (100 results are saved), the gauge will display "Memory Full". You must "Clear" a result to save another result.

When you "Clear" a result, select the F2 (Clear) key. The result that is currently displayed will be cleared after you select the Enter key. You may also clear all results by selecting the Zero key and all will be cleared after selecting the Enter key. The DFS II gauge will indicate how many results remain in memory, e.g. "1 of 9 Saved", "1 of 8 Saved", etc.



APPLYING STATISTICS TO YOUR BREAK TEST RESULT

The DFS II Series gauge will calculate statistics for your Break Test results saved in the gauge memory. The gauge will calculate and display the following:

- Mean
- Coefficient of Variation (COV)
- % Difference
- Standard Deviation

The "Statistics" function is part of the "Save" function within the DFS II Series gauge. To calculate and display statistics from the Home display, select the F3 (More) key. Then select the "I" key. Next select the F3 (More) key for gauge statistics.

View Mean

The first calculated statistic is Mean. The DFS II Series gauge will display the average of the number of results saved in memory. In addition to the Mean value, the gauge will also display the Maximum and Minimum values on which the Mean was calculated.

Select the F1 (Xmit) key to transmit the displayed information through the digital output port.

Select F2 (COV) to calculate and display the next statistic- Coefficient of Variation.

Select F3 (More) to go to the next statistical operand- % Difference.

View COV (Coefficient of Variation)

COV is displayed after Mean. The DFS II Series gauge will display the COV value and the Standard Deviation and Mean used to calculate this result.

Select the F1 (Xmit) key to transmit the displayed information through the selected communications port.

Select F2 (%Diff) to calculate and display the next statistic- % Difference.

Select F3 (More) to go to the next statistical operand- Standard Deviation.



View % Difference

% Difference is displayed after COV. The DFS II Series gauge will display the % Difference between successive results beginning with Result #1 compared to Result #2. Use the LEFT and RIGHT navigation keys to change Result Numbers.

Select the F1 (Xmit) key to transmit the displayed information through the selected communications port.

Select F2 (S-Dev) to calculate and display the next statistic- Standard Deviation.

Select F3 (More) to go to the next statistical operand- Mean.

View Standard Deviation

Standard Deviation is displayed after % Difference. Standard Deviation uses the n-1 method. The DFS II Series gauge will display the Standard Deviation, Variance and Mean of the results saved in memory.

Select the F1 (Xmit) key to transmit the displayed information through the selected communications port.

Select F2 (Mean) to calculate and display the next statistic- Mean.

Select F3 (More) to go to the Save display.



USING FILTERS

The DF II Series digital force gauge supplies two types of filtering. Filtering may be useful with applications that are “noisy” or susceptible to vibration effects, e.g., gauges measuring extremely low forces below 250gf. Filtering may be used to “dampen” the effects of these external conditions in order to provide you with a more stable display of information.

DISPLAY FILTER

The Display Filter is also called the Normal Filter. The default display update rate for the DF II Series is 10Hz. The display data rate may be reduced to 4Hz (maximum data averaging before values are displayed). Adjusting the Display Filter affects the instantaneous force measurement results displayed in Normal mode.

PEAK FILTER

The Peak Filter affects the peak tension and compression values. The default Peak Filter is set at 1 KHz. At this rate, the gauge updates quickly with minimal averaging for peak load indication. The Peak Filter may be adjusted to 10Hz, 100Hz, 1 KHz, and 7 KHz for the DFE II or 10 KHz for the DFS II.

FILTER SETUP

The DF II Series filters are setup from the Main Setup Menu. From the Home display, press the F3 (More) key three times.

Use the UP or DOWN navigation key to position the cursor arrow next to the "Filters" option. Select ENTER.

DISPLAY FILTER SETUP

From the Main Filter Setup display, you may set the Display and Peak filter rate. The cursor arrow will appear next to the Display filter option, "Disp 10 Hz". This is the default display update rate. To change the Display Filter rate to 4Hz, depress the UP or DOWN navigation key. The display rate will change between 10Hz and 4Hz. Select ENTER when the desired rate is displayed.

PEAK FILTER SETUP

From the Display Filter setup, depress F1 (Peak) to change the Peak Filter setup. Selecting F1 (Peak) will position the cursor arrow next to the "Peak" label. Use the UP and DOWN arrow to adjust the peak sample rate to the desired setting. The peak sample rate default is 10KHz (10kHz) and may be changed to 1KHz, 100 Hz and 10Hz respectively. Select ENTER to apply filter rate.

USING CONTACT CLOSURE (DFS II only)

The DFS II Series digital force gauge can be used to identify two types of contact closure events:

- Break (Open) Connection
- Make (Closed) Connection

The DFS II Series digital gauge will freeze its display at the force that was required to sense an event change in a switch operation.

BREAK (OPEN) CONNECTION

The Break or Open Connection switch sensor operates when the gauge has been setup to look for an external signal change from 1-0 (Low).

The gauge setup option is called OPEN.

The DFS II will measure the force being applied to a switch and will display the peak force that caused the switch to "Open" or "break". If the "Pass-Fail" option is used, the gauge will also display whether or not the force requirement was met and indicate either a "Pass" or "Fail" label with the displayed result.

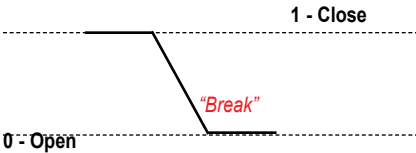

MAKE (CLOSE) CONNECTION

The Make or Close Connection switch sensor operates when the gauge has been setup to look for an external signal change from 0-1 (High).

The gauge setup option is called CLOSE.

The DFS II will measure the force being applied to a switch and will display the peak force that caused the switch to "Close" or "make". If the "Pass-Fail" option is used, the gauge will also display whether or not the force requirement was met and indicate either a "Pass" or "Fail" label with the displayed result.

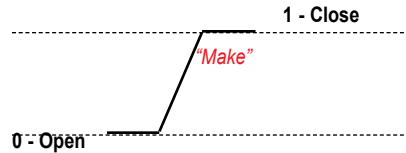

CONTACT CLOSURE OPERATION

The contact closure feature must be specified in the gauge setup and the gauge must be placed in Contact Closure Mode. When in Contact Closure mode, the DFS II Series gauge will “freeze” the display at the load that caused a switch “make” or “break”.

The DFS II Series gauge must have a cable that jumpers Pins 8 and 10 and that connects the switch to the force gauge.

CONTACT CLOSURE MODE

The DFS II Series will indicate that the gauge is in the Contact Closure mode. The mode indicator will display as “OFRZ” for a “break” setup or as “CFRZ” for a “make” setup. The load measurement will represent the actual load that was sensed by the gauge when the switch was “opened” or “closed”. Units may be changed and results may be saved in the gauge memory for statistical calculations.

CONTACT CLOSURE PASS-FAIL

The DFS II Series gauge’s Pass-Fail feature can be used with the Contact Closure Mode. Pass or Fail limits may be configured by the user in the gauge setup. When this feature is enabled, the DFS II Series gauge will display a green “PASS” or a red “FAIL” based on the limits that were configured and the load that is displayed by the gauge. The Pass or Fail limits may be based on a RANGE or on a NOMINAL VALUE with BANDWIDTH. See “Using Pass-Fail Limits” for more information.

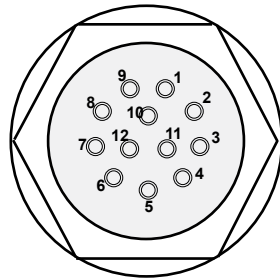

PIN	SYMBOL	I/O	PURPOSE	DESCRIPTION
1	TXD	O	RS-232	Transmitted Data
2	RXD	I	RS-232	Received Data
3	GND	O	Ground	Digital Ground
4		O	Clock	Mitutoyo Clock
5		O	Ready	Mitutoyo Ready
6		I	Request	Mitutoyo Request
7		O	Data	Mitutoyo Data
8		I	Detect	Sense Contact Closure
9		O	Setpoint	Setpoint Output Signal
10		-	Ground	Digital Ground
11		-	Analog GND	Analog Ground
12		O	Analog SIG	Analog Output

CONTACT CLOSURE SETUP

Contact closure is specified using the DFS II Gauge Setup menu.

From the HOME display, press F3 (More) four times to get to the CONTACT CLOSURE option.

Use the UP or DOWN navigation key to cursor to the CONTACT CLOSURE option and select ENTER.

CONTACT CLOSURE - ON/OFF

If this option is selected, the DFS II Series gauge will not freeze its display when a switch event has occurred. There is no Contact Closure Mode available. Select F1 (ON/OFF) to enable or disable contact closure.

CONTACT CLOSURE - OPEN TYPE

If this option is selected, the DFS II Series gauge will freeze its display when a switch has been opened (break). Select F1 (OPEN) to specify the DFS II to look for a switch "break". Select F2 (Back) to turn contact closure Off.

CONTACT CLOSURE - CLOSE TYPE

If this option is selected, the DFS II Series gauge will freeze its display when a switch has been closed (make). Select F1 (CLOSE) to specify the DFS II to look for a switch "make". Select F2 (Back) to turn contact closure Off.

SPECIFICATIONS

	DFE II	DFS II	DFS II-R	DFS II-R-SLC	DFS II-R-STS
Accuracy: % of full scale	±0.25%	±0.1%	±0.1%	±0.25% ¹	0.3%
Data Sampling Rate (KHz):	7	10	10	10	10
Peak Capture Rate (Hz):	7000	10,000	10,000	10,000	10,000
Display Update Rate (Hz):		10	10	10	10
Display Resolution:	1000:1	10,000:1	10,000:1	10,000:1	10,000:1
Tare Capacity (% Full Scale):	110%	110%	110%	110%	110%
Overload Protection (% Full Scale):	150%	150%	150%	150%	150%
Display Type:	Color	Color	Color	Color	Color
Memory (No. of Saved Results):	20	100	100	100	100

Note 1: SLC-02000, SLC-05000 and SLC-10000 capacities used with the DFS II-R-ND have a calibration accuracy of +0.5% of full scale.

Common Specifications to all DF Models

Temperature Rating

Operating Temperature: 40° to 100°F (4° to 38°C)

Storage Temperature: 0° to 130°F (-17° to 54°C)

Temperature Stability: ±0.015% per °F

Relative Humidity: 20% to 85% non-condensing

Conformity: BS EN 61010-1: 2010 Safety Requirements for Electrical Equipment, BS EN 61326--1: 2006 Electrical Equipment for Measurement, Control and Laboratory use: General Requirements BS EN 61326--2-3: 2006 Electrical Equipment for Measurement, Control and Laboratory use: Transducers with integrated or remote signal conditioning, RoHS and WEEE

Power:

Battery (Nickel Metal Hydride) or direct AC 120/230Vac

Battery Life:

With Dimming ON: 20 Hours

With dimming OFF: 16 Hours

Software:

Use with NEXYGEN DF2 or Forcetest software

Instrument Weight:

1.5 lbs (0.7 kg)

Shipping Weight:

4 lbs (2 kg)

Warranty Period:

1 year

FEATURES & FUNCTIONS

	DFE II	DFS II	DFS II-R	DFS II-R-ND
Operating Modes				
Normal	Std	Std	Std	Std
Peak (Tension & Compression)	Std	Std	Std	Std
Load Limits	Std	Std	Std	Std
Load Average	Std	Std	Std	Std
Break Detection	-	Std	Std	Std
Contact Closure	-	Std	Std	Std
Peak (Torque)	-	-	-	Std
Tolerances (Pass/Fail)	Std	Std	Std	Std
Outputs				
Analog	Std	Std	Std	Std
Digital RS232	Std	Std	Std	Std
USB	Std	Std	Std	Std
Mitutoyo	Std	Std	Std	Std
Output Filters				
Peak	Std	Std	Std	Std
Display	Std	Std	Std	Std
Statistics				
Mean	Std	Std	Std	Std
Max/Min	Std	Std	Std	Std
COV	Std	Std	Std	Std
Standard Deviation	Std	Std	Std	Std
% Difference	Std	Std	Std	Std
Password	Std	Std	Std	Std
Auto Dimming	Std	Std	Std	Std
Multiple Languages	Std	Std	Std	Std
Graphing		Std	Std	Std

DIMENSIONS

Gauge with Integral Load Cell Sensor

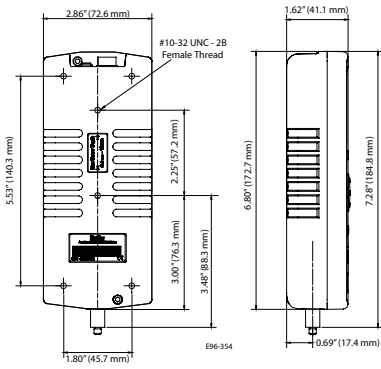

Gauge with Remote Load Cell Sensor

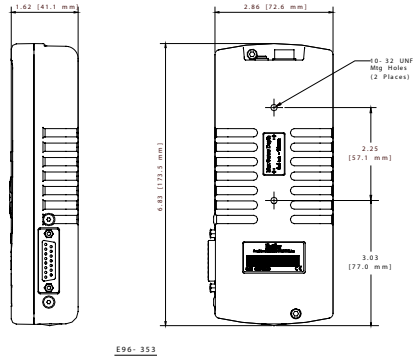

Interchangeable Sensors for DFS-R-ND

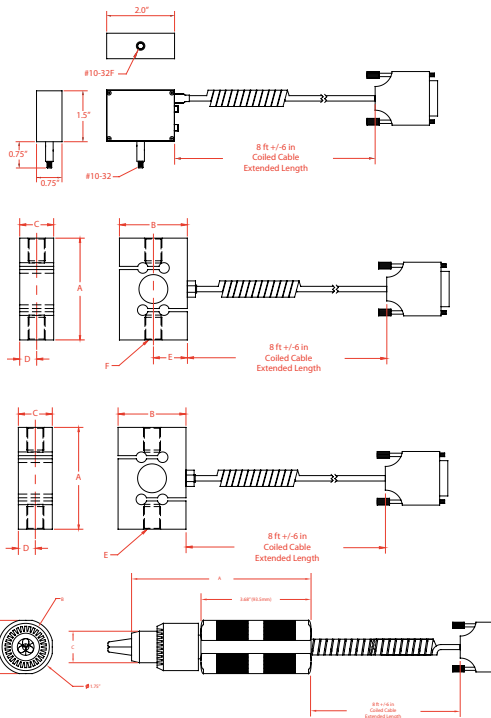

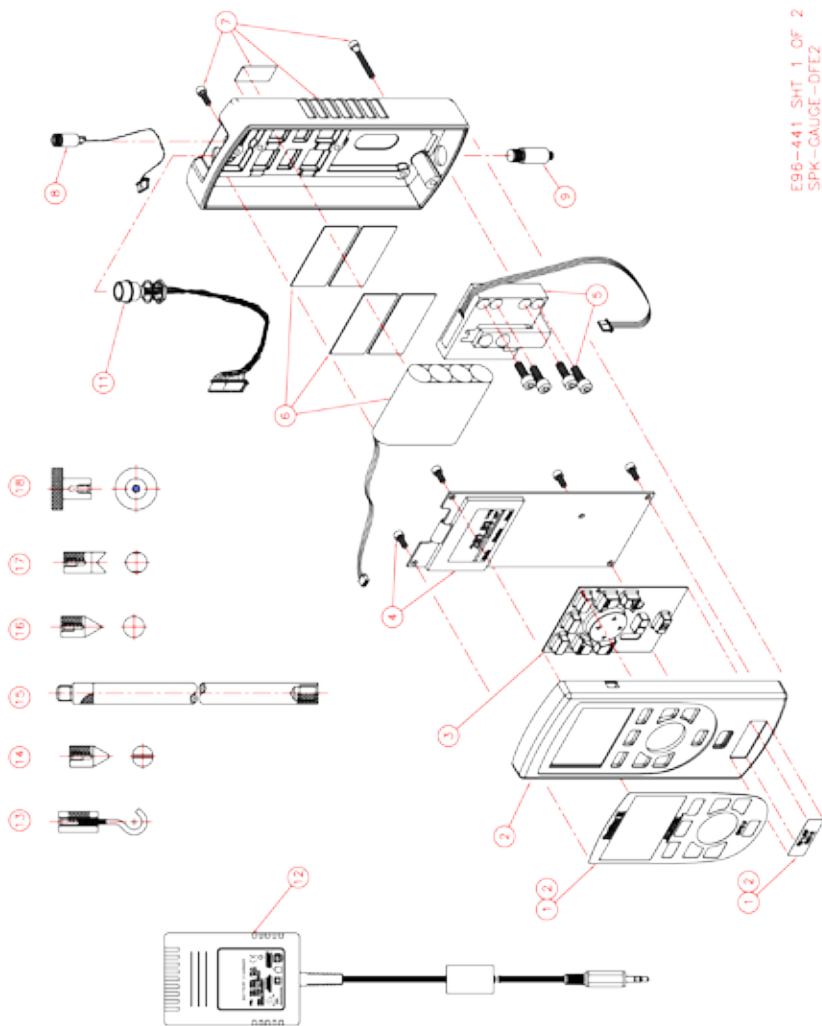

DFE2 GAUGE SERIES		DFE2 MODELS									
ITEM	PART NO.	DESCRIPTION	DFE2-002	DFE2-010	DFE2-025	DFE2-050	DFE2-100	DFE2-200	DFE2-500		
1	SPK-DFE2-109A	TOP HOUSING ASSY, 2 LBF	1								
1	SPK-DFE2-109B	TOP HOUSING ASSY, 10 LBF		1							
1	SPK-DFE2-109C	TOP HOUSING ASSY, 25 LBF			1						
1	SPK-DFE2-109D	TOP HOUSING ASSY, 50 LBF				1					
1	SPK-DFE2-109E	TOP HOUSING ASSY, 100 LBF					1				
1	SPK-DFE2-109F	TOP HOUSING ASSY, 200 LBF						1			
1	SPK-DFE2-109G	TOP HOUSING ASSY, 500 LBF							1		
2	SPK-DF-110	KEYPAD	1	1	1	1	1	1	1	1	1
3	SPK-DFE2-111	PC BOARD ASSEMBLY	1	1	1	1	1	1	1	1	1
4	SPK-DF-0002	LOAD CELL ASSY, 2 LBF	1								
4	SPK-DF-0010	LOAD CELL ASSY, 10 LBF		1							
4	SPK-DF-0025	LOAD CELL ASSY, 25 LBF			1						
4	SPK-DF-0050	LOAD CELL ASSY, 50 LBF				1					
4	SPK-DF-0100	LOAD CELL ASSY, 100 LBF					1				
4	SPK-DF-0200	LOAD CELL ASSY, 200 LBF						1			
4	SPK-DF-0500	LOAD CELL ASSY, 500 LBF							1		
5	SPK-DF2-112	BATTERY PACK ASSY	1	1	1	1	1	1	1	1	1
6	SPK-DF2-113	BOTTOM HOUSING ASSY	1	1	1	1	1	1	1	1	1
7	SPK-DF-114	POWER JACK CABLE ASSY	1	1	1	1	1	1	1	1	1
8	SPK-DF-115A	ADAPTER, LOAD CELL SHAFT	1								
8	SPK-DF-115B	ADAPTER, LOAD CELL SHAFT		1	1	1	1	1	1	1	1
8	SPK-DF-115C	ADAPTER, LOAD CELL SHAFT									
9	SPK-FMG-USB	USB CABLE DF2 SERIES	1	1	1	1	1	1	1	1	1
10	SPK-DF-117	CABLE ASSEMBLY, 12 PIN	1	1	1	1	1	1	1	1	1
11	SPK-DF2-UNV	BATTERY CHARGER, UNIVERSAL	1	1	1	1	1	1	1	1	1
12	SPK-FMG-012A	ADAPTER, HOOK	1	1	1	1	1	1	1	1	1
12	SPK-FMG-012B	ADAPTER, HOOK									
12	SPK-FMG-012C	ADAPTER, HOOK									
13	SPK-FMG-008A	ADAPTER, CHISEL POINT	1	1	1	1	1	1	1	1	1
13	SPK-FMG-008B	ADAPTER, CHISEL POINT									
14	SPK-FMG-013A	ROD, EXTENSION	1	1	1	1	1	1	1	1	1
14	SPK-FMG-013B	ROD, EXTENSION									
15	SPK-FMG-009A	ADAPTER, POINT	1	1	1	1	1	1	1	1	1
15	SPK-FMG-009B	ADAPTER, POINT									
16	SPK-FMG-010A	ADAPTER, NOTCH	1	1	1	1	1	1	1	1	1
16	SPK-FMG-010B	ADAPTER, NOTCH									
17	SPK-FMG-011A	ADAPTER, FLAT	1	1	1	1	1	1	1	1	1
17	SPK-FMG-011B	ADAPTER, FLAT									
18	SPK-DF-RS232	CABLE ASSY, FORCE GAUGE TO RS232	1	1	1	1	1	1	1	1	1
19	SPK-DF-118	CARRYING CASE ASSY	1	1	1	1	1	1	1	1	1
20	SPK-DF2-123	OPERATION INSTRUCTIONS, DF2 SERIES	1	1	1	1	1	1	1	1	1

E96-442-SHT 1 OF 2
SPK-GAUGE-DFS2

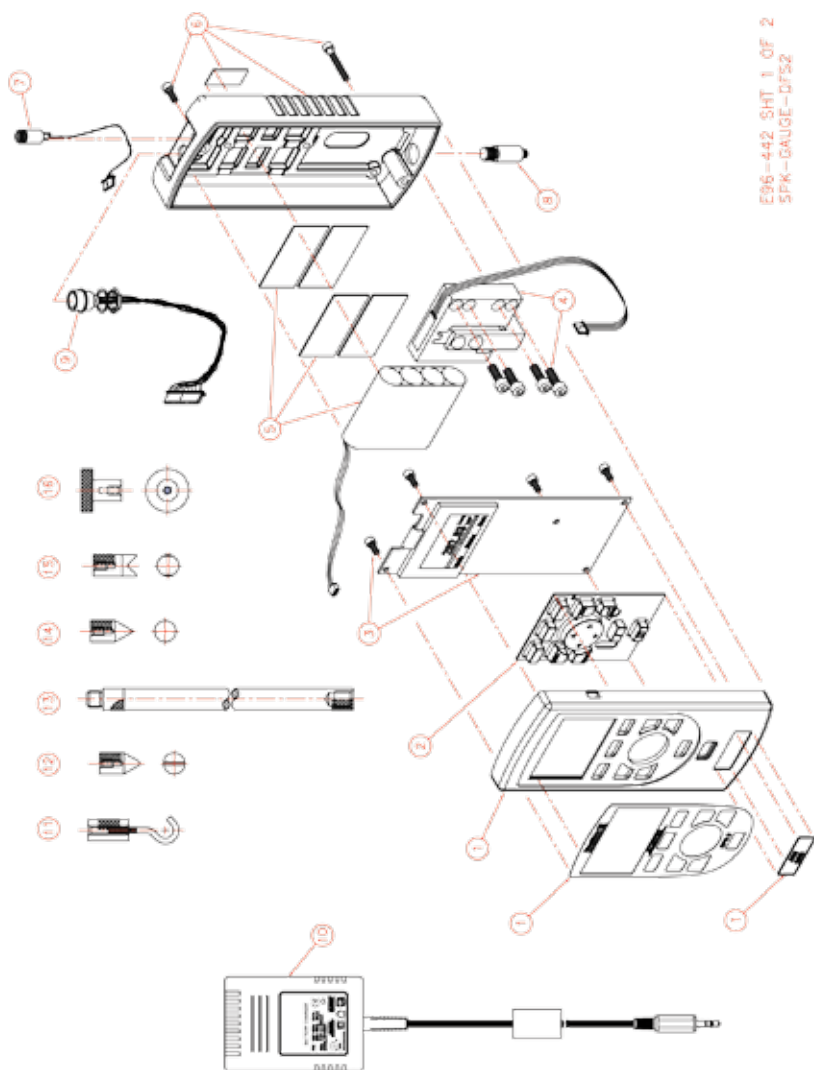

DFS2 GAUGE SERIES		DFS2 MODELS								
ITEM	PART NO.	DESCRIPTION	DFS2-2500	DFS2-002	DFS2-010	DFS2-025	DFS2-050	DFS2-100	DFS2-200	DFS2-500
1	SPK-DF52-121A	TOP HOUSING ASSY, 250 DF	1							
1	SPK-DF52-121B	TOP HOUSING ASSY, 2 LBF		1						
1	SPK-DF52-121C	TOP HOUSING ASSY, 10 LBF			1					
1	SPK-DF52-121D	TOP HOUSING ASSY, 25 LBF				1				
1	SPK-DF52-121E	TOP HOUSING ASSY, 50 LBF					1			
1	SPK-DF52-121F	TOP HOUSING ASSY, 100 LBF						1		
1	SPK-DF52-121G	TOP HOUSING ASSY, 160 LBF							1	
1	SPK-DF52-121H	TOP HOUSING ASSY, 300 LBF								1
2	SPK-DF-110	PC BOARD	1	1	1	1	1	1	1	1
3	SPK-DFS2-122	PC BOARD ASSEMBLY	1	1	1	1	1	1	1	1
4	SPK-DF-2506	LOAD CELL ASSY, 250 DF	1							
4	SPK-DF-0002	LOAD CELL ASSY, 2 LBF								
4	SPK-DF-0010	LOAD CELL ASSY, 10 LBF			1					
4	SPK-DF-0025	LOAD CELL ASSY, 25 LBF				1				
4	SPK-DF-0050	LOAD CELL ASSY, 50 LBF					1			
4	SPK-DF-0100	LOAD CELL ASSY, 100 LBF						1		
4	SPK-DF-0200	LOAD CELL ASSY, 200 LBF							1	
4	SPK-DF-0500	LOAD CELL ASSY, 500 LBF								1
5	SPK-DF-112	BATTERY PACK ASSEMBLY	1	1	1	1	1	1	1	1
6	SPK-DF-113	BOTTOM HOUSING ASSEMBLY	1	1	1	1	1	1	1	1
7	SPK-DF-114	POWER JACK CABLE ASSEMBLY	1	1	1	1	1	1	1	1
8	SPK-DF-115A	LOAD CELL SHAFT	1							
8	SPK-DF-115B	LOAD CELL SHAFT		1	1	1	1	1	1	1
8	SPK-DF-115C	LOAD CELL SHAFT								1
9	SPK-DF-117	CABLE ASSEMBLY, 12 PIN	1	1	1	1	1	1	1	1
10	SPK-DF-1UNV	BATTERY CHARGER, UNIVERSAL	1	1	1	1	1	1	1	1
11	SPK-FMG-012A	ADAPTER, HOOK	1	1	1	1	1	1	1	1
11	SPK-FMG-012B	ADAPTER, HOOK								1
11	SPK-FMG-012C	ADAPTER, HOOK								1
12	SPK-FMG-008A	ADAPTER, CHISEL POINT	1	1	1	1	1	1	1	1
12	SPK-FMG-008B	ADAPTER, CHISEL POINT								1
13	SPK-FMG-013A	ROD, EXTENSION	1	1	1	1	1	1	1	1
13	SPK-FMG-013B	ROD, EXTENSION								1
14	SPK-FMG-009A	ADAPTER, POINT	1	1	1	1	1	1	1	1
14	SPK-FMG-009B	ADAPTER, POINT								1
15	SPK-FMG-010A	ADAPTER, NOTCH	1	1	1	1	1	1	1	1
15	SPK-FMG-010B	ADAPTER, NOTCH								1
16	SPK-FMG-011A	ADAPTER, FLAT	1	1	1	1	1	1	1	1
16	SPK-FMG-011B	ADAPTER, FLAT								1
17	SPK-DF-RS232	CABLE ASSEMBLY, FORCE GAUGE TO RS232	1	1	1	1	1	1	1	1
18	SPK-DF-118	CARRYING CASE ASSEMBLY	1	1	1	1	1	1	1	1
19	SPK-DF-123	OPERATION INSTRUCTIONS, DF2 SERIES	1	1	1	1	1	1	1	1
20	SPK-FMG-J20	USB CABLE DF2 SERIES	1	1	1	1	1	1	1	1

ES6-443, REV. B, DF 2
SPK-0606-DF32

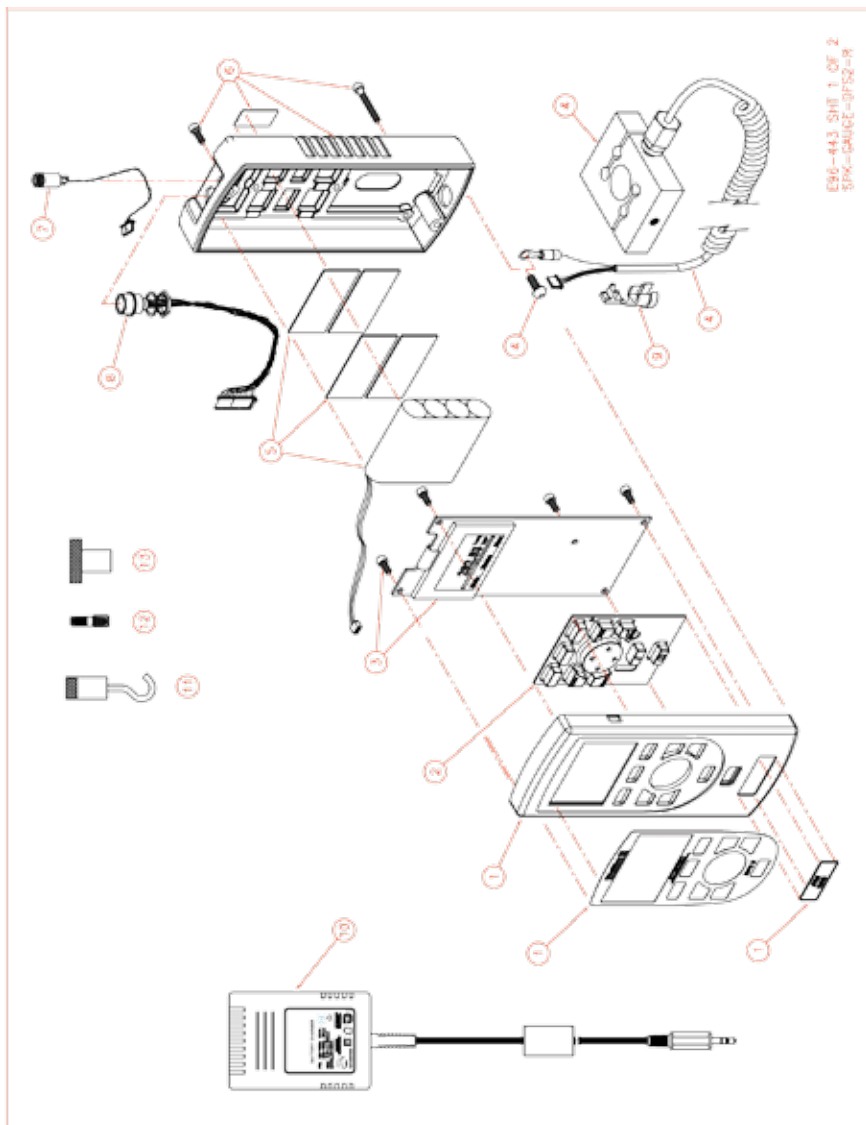

DFS2-R GAUGE SERIES		DFS2-R MODELS							
ITEM	PART NO.	DESCRIPTION	DFS2-R-250G	DFS2-R-0002	DFS2-R-0010	DFS2-R-0025	DFS2-R-0040	DFS2-R-0200	DFS2-R-1000
1	SPK-DFS2-121A	TOP CASE ASSEMBLY, 250 GF	1						
1	SPK-DFS2-121B	TOP CASE ASSEMBLY, 2 LBF		1					
1	SPK-DFS2-121C	TOP CASE ASSEMBLY, 10 LBF			1				
1	SPK-DFS2-121D	TOP CASE ASSEMBLY, 20 LBF				1			
1	SPK-DFS2-121E	TOP CASE ASSEMBLY, 50 LBF					1		
1	SPK-DFS2-121F	TOP CASE ASSEMBLY, 100 LBF						1	
1	SPK-DFS2-121G	TOP CASE ASSEMBLY, 200 LBF							1
1	SPK-DFS2-121H	TOP CASE ASSEMBLY, 500 LBF							
1	SPK-DFS2-121J	TOP CASE ASSEMBLY, 1000 LBF							
2	SPK-DF-1110	KEYPAD	1		1				
3	SPK-DFS2-122	PC BOARD ASSEMBLY	1		1				
4	SPK-DFS-R-250G	LOAD CELL ASSY, 250 GF, REMOTE	1		1				
4	SPK-DFS-R-0002	LOAD CELL ASSY, 2 LBF, REMOTE		1					
4	SPK-DFS-R-0010	LOAD CELL ASSY, 10 LBF, REMOTE			1				
4	SPK-DFS-R-0025	LOAD CELL ASSY, 25 LBF, REMOTE				1			
4	SPK-DFS-R-0050	LOAD CELL ASSY, 50 LBF, REMOTE					1		
4	SPK-DFS-R-0100	LOAD CELL ASSY, 100 LBF, REMOTE						1	
4	SPK-DFS-R-0200	LOAD CELL ASSY, 200 LBF, REMOTE							1
4	SPK-DFS-R-0500	LOAD CELL ASSY, 500 LBF, REMOTE							
4	SPK-DFS-R-1000	LOAD CELL ASSY, 1000 LBF, REMOTE							
5	SPK-DF2-112	BATTERY PACK ASSEMBLY	1		1				
6	SPK-DF2-113	BOTTOM HOUSING ASSEMBLY	1		1				
7	SPK-DF-114	POWER JACK CABLE ASSEMBLY	1		1				
8	SPK-DF-117	CABLE ASSEMBLY, 12 PIN	1		1				
9	SPK-DFS-R-137	BUSHING, STRAIN RELIEF	1		1				
10	SPK-DF2-UNV	BATTERY CHARGER, UNIVERSAL	1		1				
11	SPK-FMG-012A	ADAPTER, HOOK	1		1				
11	SPK-DFS-R-138	HOOK						1	
11	SPK-FMG-012C	ADAPTER, HOOK							1
12	SPK-DFS-R-139	ADAPTER, 1/4-28 M TO 5/16-18 M						1	
12	SPK-DFS-R-140	ADAPTER, 5/16-18 M TO 1/2-20 M							1
13	SPK-FMG-011A	ADAPTER, FLAT	1		1				
13	SPK-FMG-011B	ADAPTER, FLAT						1	
14	SPK-DF-RS232	CABLE, FORCE GAUGE TO RS232	1		1				
15	SPK-DF-118	CARRYING CASE ASSEMBLY	1		1				
16	SPK-DF2-123	OPERATION MANUAL, DF2 SERIES	1		1				
17	SPK-FMG-USB	USB CABLE DF2 SERIES	1		1				

DFS-143 SHIT A DF 2
SPK-GAUGE-DF2-R

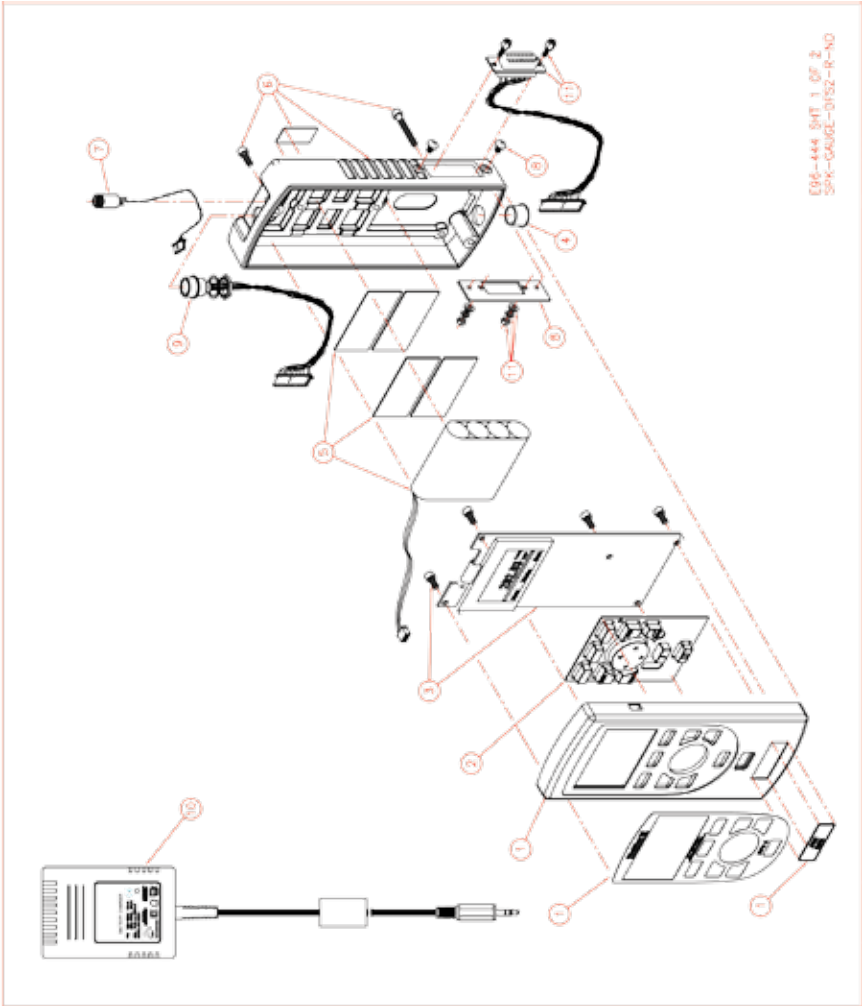

DFS2-R-ND GAUGE SERIES

ITEM	PART NO.	DESCRIPTION	DFS2-R-ND
1	SPK-DFS2-121	TOP HOUSING ASSEMBLY	1
2	SPK-DF-110	KEYPAD	1
3	SPK-DFS2-R-ND-148	PC BOARD ASSEMBLY	1
4	SPK-DFS-R-ND-124	HOLE PLUG, 1/2"	1
5	SPK-DF2-112	BATTERY PACK ASSEMBLY	1
6	SPK-DFS2-R-ND-126	BOTTOM HOUSING REMOTE ASSY	1
7	SPK-DF-114	POWER JACK CABLE ASSEMBLY	1
8	SPK-DFS-R-ND-125	SOCKET MOUNTING PLATE ASSY	1
9	SPK-DF-117	CABLE ASSEMBLY, 12 PIN	1
10	SPK-DF2-UNIV	BATTERY CHARGER, UNIVERSAL	1
11	SPK-DFS-R-ND-127	CABLE ASSEMBLY, 15 PIN	1
12	SPK-DF-118	CARRYING CASE ASSY (NOT SHOWN)	1
13	SPK-DFS-123	OPERATION MANUAL, DFS2 SERIES (NOT SHOWN)	1
14	SPK-FMG-USB	USB CABLE DF2 SERIES (NOT SHOWN)	1
15	SPK-DF-RS232	CABLE, FORCE GAUGE TO RS232 (NOT SHOWN)	1

E96-444 SHT 2 OF 2
SPK-GAUGE-DFS2-R-ND



International Symbols

WEEE Directive

This equipment contains electrical and electronic circuits and should not be directly disposed of in a landfill site.



RoHS

This product is RoHS and China RoHS compliant. This symbol indicates the equipment contains some restricted hazardous substances above the recommended level, and may offer potential harm to the environment after 15 years from date of manufacture.



www.ametektest.com

UK

Lloyd Instruments Ltd
Tel +44 (0)1243 833 370
uk-far.general@ametek.co.uk

France

AMETEK S.A.S.
Tel +33 (0)1 30 68 89 40
general.lloyd-instruments@ametek.fr

Germany

AMETEK GmbH
Tel +49 (0)2159 9136 510
info.mct-de@ametek.de

Denmark

AMETEK Denmark
Tel +45 4816 8000
ametekdk@ametek.com

USA

AMETEK Measurement & Calibration Technologies
Tel +1 (727) 538 6000
chatillon.fl-lar@ametek.com

India

AMETEK Instruments India Pvt Ltd.
Tel +91 22 2836 4750
ametekdk@ametek.com

Singapore

AMETEK Singapore Pte Ltd
Tel +65 6484 2388
ametekdk@ametek.com

China

AMETEK Commercial Enterprise - Shanghai
Tel +86 21 5868 5111

AMETEK Commercial Enterprise - Beijing
Tel +86 10 8526 2111
lloyd@ametek.com.cn